

Vol. 23

 **TIMELY**  
HARDWARE

 **HARDWARE** **B&M** **COMPANY**

\$20.00

# **B&M HARDWARE**

## **Timely Hardware**

Window & Door Hardware  
House Restoration Hardware  
Furniture & Cabinet Hardware  
Classic, Traditional & Vintage Styles



Timely Hardware • 4125 Avenida de la Plata • Oceanside CA 92056

Order Hotline: (800) 783-2212 • Customer Service: (760) 630-1522 • Fax: (760) 630-8536

Email: [info@bmhardware.com](mailto:info@bmhardware.com)

Website: [www.timelyhardware.com](http://www.timelyhardware.com)

HIGH QUALITY - WHOLESALE PRICES - SAME DAY SHIPPING



# Timely Hardware



A DIVISION OF B&M HARDWARE CO.

email: [info@bmhardware.com](mailto:info@bmhardware.com)

**Good to know: brass repels  
germs, bacteria and viruses**



Our warehouse near San Diego CA, where our products are stocked.  
From here we ship your orders on the same day they are received.

## BAR-CODE LABELS

Do you need bar-code labels on your products?  
We can do it for you.  
Please contact us to see how you can use this service.



## TABLE OF CONTENTS

<b>BUILDERS' HARDWARE</b>	PAGE
<b>Door hardware</b> .....	<b>1-36</b>
Deadbolts .....	29
Door accessories .....	31
Door handles .....	10-12
Door hinges .....	36, 45
Door key hole plates and keys .....	31
Door knobs .....	14-16
<b>Door latch sets: how to order</b> .....	<b>26-27</b>
Door latches .....	25
Door plates .....	16-19
Door roses .....	20-21
Door spindles .....	8-9
Door strikes .....	30
Entrance door mortise locks .....	1-7
<b>Entry lock sets: how to order</b> .....	<b>6-7 , 22-24</b>
Mortise locks - interior doors .....	28
Mortise locks - exterior doors .....	1-7
Picture (molding) hooks .....	117
Screen door hardware .....	32-33
Surface bolts .....	34-35
<b>Window hardware</b> .....	<b>34-45</b>
Casement window hardware .....	40-41
Sash window hardware .....	37-39
Shutter hardware .....	42-45
Storm screen/window hardware .....	43
Surface bolts .....	34-35
Transom window hardware .....	44
<b>GENERAL HARDWARE</b>	
<b>Furniture and cabinet hardware</b> .....	<b>45-127</b>
Armoire hinges .....	50
Art deco, streamline, moderne styles .....	84-85
Arts & crafts, craftsman and mission styles .....	88-93
Bakelite, waterfall hardware .....	105
Bed parts .....	95
Bookcase hardware .....	76 , 107
Cabinet door pulls .....	54-57 , 80-81
Card pulls and label holders .....	112

Continues on next page

## TABLE OF CONTENTS

PRODUCT	PAGE
Casters and toe caps .....	108-111
China cabinet pulls .....	80-81
Chippendale style .....	60-61 , 64-65 , 67 , 79-80
Colonial revival .....	60-61 , 64-70, 73 , 78-80
Contemporary classic .....	54-56 , 75, 86-87, 90-91
Depression era .....	66 , 73
Desk hardware .....	112-115
Displays .....	128
Drawer drop pulls with 1 post .....	66-71 , 88-89
Drawer drop pulls with 2 posts .....	59-65
Drawer pulls .....	52-70
Drawer/bin pulls .....	52-53
Eastlake style .....	62 , 67, 70-71, 78, 118
File cabinet hardware .....	112-113
Glass knobs and pulls .....	122-127
Heppelwhite, sheraton, Duncan Phife styles .....	65-67 , 73 , 78-79 , 111
Hinges .....	45-51 , 111
Hoosier cabinets hardware .....	96-99
Ice box and refrigerator hardware .....	104
Iron hardware (black) .....	100-102
Keyhole plates .....	78-81
Knobs .....	71-77
Label holders and card pulls .....	112
Latches. Catches, turns .....	81-83
Locks and keys .....	114-116
Mirror hardware .....	111
Miscellaneous hardware .....	117
Morris chair hardware .....	106
Pendant (drop) pulls .....	68-70
Porcelain knobs .....	121
Push button pulls .....	81
Ring pulls .....	66-71
Screws and fasteners .....	93-95
"Swan neck" pulls .....	59-10
Victorian styles .....	53 , 56 , 59 , 62-63 , 67 , 70-74 , 78-80 , 82-83 , 100-103
Wood products .....	118-120
<b>Household .....</b>	<b>101-117</b>
Hall tree, costumer and wall hooks .....	101-104
Picture (molding) hooks .....	117



# HIGH QUALITY ENTRANCE DOOR MORTISE LOCKS

For new doors and for replacing locks in old doors

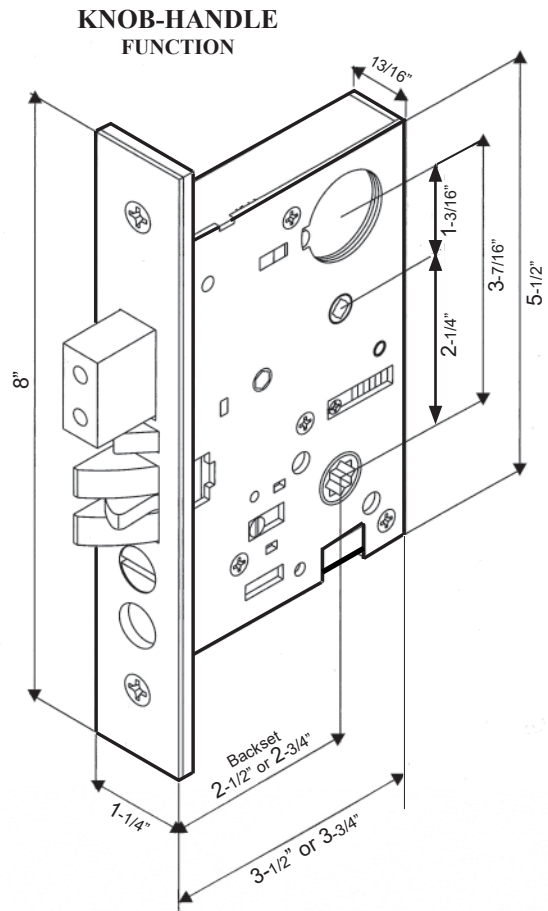
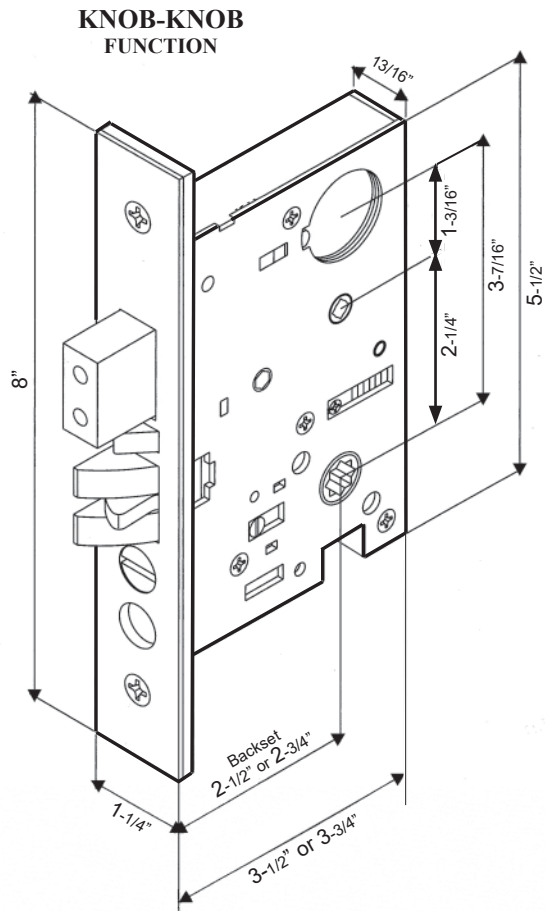

Full Number	set Number	Backset	Function	Type
8895	95	2 3/4"	K-K	With egress
8898	98	2 1/2"	K-K	With egress
8905	05	2 3/4"	K-K	Without egress
8908	08	2 1/2"	K-K	Without egress

Full Number	set Number	Backset	Function	Type
8896	96	2 3/4"	K-H	With egress
8899	99	2 1/2"	K-H	With egress
8906	06	2 3/4"	K-H	Without egress
8909	09	2 1/2"	K-H	Without egress

For detailed description and specs see pages 2-5

Guide for choosing locks on pages 6-7

Guide for choosing complete lock sets on pages 22-24



**High quality, precision made mortise lock cases for entrance doors**  
**For new doors or as replacements for Sargent, Corbin and Russwin locks in old doors**  
**Field reversible**



ANSI CODE F20  
With egress

**Knob-Knob  
function**



ANSI CODE F08  
Without egress

**2 1/2"  
backset**

- 8898-PB** polished brass
- 8898-PL** lacquered polished brass
- 8898-OB** oil rubbed bronze
- 8898-BN** brushed nickel
- 8898-PN** polished nickel
- 2 1/2" backset
- Entrance - with egress
- Knob-knob function

Trim available  
in 5 finishes

- 8908-PB** polished brass
- 8908-PL** lacquered polished brass
- 8908-OB** oil rubbed bronze
- 8908-BN** brushed nickel
- 8908-PN** polished nickel
- 2 1/2" backset
- Entrance - without egress
- Knob-knob function

Backset: 2 1/2"  
 Steel lock case: 3 3/4" wide (deep), 5 1/2" high, 13/16" (.812") thick  
 Brass face plate: 1 1/4" wide, 8" high  
 Keyway cylinder spacing: 3 7/16" (3.43")  
 Thumb turn spacing: 2-1/4"  
 Brass strike plate: 4 7/8" high, 1 1/4" wide (1 7/8" wide at lip)  
 For 1 3/4" thick doors (range: 1 5/8" - 1 7/8")

- Anti-friction latch and auxiliary (guard) latch
- Stop/release buttons
- Deadbolt with 2 saw-proof hardened steel inserts
- Cylinder plug and dust box
- Includes keyway cylinder and 3 keys
- Face plate detachable to set cylinder keyway and plug, and to reverse handing
- 1 year warranty on the lock or its parts (excluding normal wear)
- **Locks are field reversible (shipped right-handed)**

Will work just as well  
in new doors as in  
the the restoration of  
doors of old houses

For thicker doors order them with thick door kits  
Additional keyway cylinders can be ordered by themselves

Mortise locks can be ordered by themselves (with keyway cylinder, 3 keys, strike plate and dust box) as shown here  
or as complete door sets with doorknobs and door trim as described in pages 22-24

**High quality, precision made mortise lock cases for entrance doors**  
**For new doors or as replacements for Sargent, Corbin and Russwin locks in old doors**  
**Field reversible**



ANSI CODE F20  
With egress

**Knob-Knob  
function**



ANSI CODE F08  
Without egress

**2 3/4"  
backset**

- 8895-PB** polished brass
- 8895-PL** lacquered polished brass
- 8895-OB** oil rubbed bronze
- 8895-BN** brushed nickel
- 8895-PN** polished nickel
- 2 3/4" backset
- Entrance with egress
- Knob-knob function

Trim available  
in 5 finishes

- 8905-PB** polished brass
- 8905-PL** lacquered polished brass
- 8905-OB** oil rubbed bronze
- 8905-BN** brushed nickel
- 8905-PN** polished nickel
- 2 3/4" backset
- Entrance - without egress
- Knob-knob function

Backset: 2 3/4"  
 Steel lock case: 3 3/4" wide (deep), 5 1/2" high, 13/16" (.812") thick  
 Brass face plate: 1 1/4" wide, 8" high  
 Keyway cylinder spacing: 3 7/16" (3.43")  
 Thumb turn spacing: 2-1/4"  
 Brass strike plate: 4 7/8" high, 1 1/4" wide (1 7/8" wide at lip)  
 For 1 3/4" thick doors (range: 1 5/8" - 1 7/8")

- Anti-friction latch and auxiliary (guard) latch
- Stop/release buttons
- Deadbolt with 2 saw-proof hardened steel inserts
- Cylinder plug and dust box
- Includes keyway cylinder and 3 keys
- Face plate detachable to set cylinder keyway and plug, and to reverse handing
- 1 year warranty on the lock or its parts (excluding normal wear)
- **Locks are field reversible (shipped right-handed)**

Will work just as well  
in new doors as in  
the the restoration of  
doors of old houses

For thicker doors order them with thick door kits  
Additional keyway cylinders can be ordered by themselves

Mortise locks can be ordered by themselves (with keyway cylinder, 3 keys, strike plate and dust box) as shown here  
or as complete door sets with doorknobs and door trim as described in pages 22-24



**High quality, precision made mortise lock cases for entrance doors**  
**For new doors or as replacements for Sargent, Corbin and Russwin locks in old doors**  
**Field reversible**



ANSI CODE F20  
With egress

**Knob-Handle  
function**



ANSI CODE F08  
Without egress

2 1/2"  
backset

- 8899-PB polished brass
- 8899-PL lacquered polished brass
- 8899-OB oil rubbed bronze
- 8899-BN brushed nickel
- 8899-PN polished nickel
- 2 1/2" backset
- Entrance - with egress
- Knob-handle function

Trim available  
in 5 finishes

- 8909-PB polished brass
- 8909-PL lacquered polished brass
- 8909-OB oil rubbed bronze
- 8909-BN brushed nickel
- 8909-PN polished nickel
- 2 1/2" backset
- Entrance - without egress
- Knob-handle function

Backset: 2 1/2"  
 Steel lock case: 3 3/4" wide (deep), 5 1/2" high, 13/16" (.812") thick  
 Brass face plate: 1 1/4" wide, 8" high  
 Keyway cylinder spacing: 3 7/16" (3.43")  
 Thumb turn spacing: 2-1/4"  
 Brass strike plate: 4 7/8" high, 1 1/4" wide (1 7/8" wide at lip)  
 For 1 3/4" thick doors (range: 1 5/8" - 1 7/8")

- Anti-friction latch and auxiliary (guard) latch
- Stop/release buttons
- Deadbolt with 2 saw-proof hardened steel inserts
- Cylinder plug and dust box
- Includes keyway cylinder and 3 keys
- Face plate detachable to set cylinder keyway and plug, and to reverse handing
- 1 year warranty on the lock or its parts (excluding normal wear)
- **Locks are field reversible (shipped right-handed)**

Will work just as well  
in new doors as in  
the the restoration of  
doors of old houses

Used with #8859, #8858, and #8857 door handles with thumb-pieces as trim on the exterior side of entrance doors, see p. 10

For thicker doors order them with thick door kits  
Additional keyway cylinders can be ordered by themselves

Mortise locks can be ordered by themselves (with keyway cylinder, 3 keys, strike plate and dust box) as shown here  
or as complete door sets with doorknobs and door trim as described in pages 22-24





**High quality, precision made mortise lock cases for entrance doors**  
**For new doors or as replacements for Sargent, Corbin and Russwin locks in old doors**  
**Field reversible**



ANSI CODE F20  
With egress

**Knob-Handle  
function**



ANSI CODE F08  
Without egress

2 3/4"  
backset

- 8896-PB** polished brass
- 8896-PL** lacquered polished brass
- 8896-OB** oil rubbed bronze
- 8896-BN** brushed nickel
- 8896-PN** polished nickel
- 2 3/4" backset
- Entrance - with egress
- Knob-handle function

Trim available  
in 5 finishes

- 8906-PB** polished brass
- 8906-PL** lacquered polished brass
- 8906-OB** oil rubbed bronze
- 8906-BN** brushed nickel
- 8906-PN** polished nickel
- 2 3/4" backset
- Entrance - without egress
- Knob-handle function

Backset: 2 3/4"  
 Steel lock case: 3 3/4" wide (deep) , 5 1/2" high , 13/16" (.812") thick  
 Brass face plate: 1 1/4" wide , 8" high  
 Keyway cylinder spacing: 3 7/16" (3.43")  
 Thumb turn spacing: 2-1/4"  
 Brass strike plate: 4 7/8" high , 1 1/4" wide (1 7/8" wide at lip)  
 For 1 3/4" thick doors (range: 1 5/8" - 1 7/8")

- Anti-friction latch and auxiliary (guard) latch
- Stop/release buttons
- Deadbolt with 2 saw-proof hardened steel inserts
- Cylinder plug and dust box
- Includes keyway cylinder and 3 keys
- Face plate detachable to set cylinder keyway and plug, and to reverse handing
- 1 year warranty on the lock or its parts (excluding normal wear)
- **Locks are field reversible (shipped right-handed)**

Will work just as well  
in new doors as in  
the the restoration of  
doors of old houses

Used with #8859, #8858, and #8857 door handles with thumb-pieces as trim on the exterior side of entrance doors, see p. 10

For thicker doors order them with thick door kits  
Additional keyway cylinders can be ordered by themselves

Mortise locks can be ordered by themselves (with keyway cylinder, 3 keys, strike plate and dust box) as shown here  
or as complete door sets with doorknobs and door trim as described in pages 22-24

# HOW TO CHOOSE AN ENTRY DOOR MORTISE LOCK

1. Do you want the lock's function to be Knob-Knob or Knob-Handle?

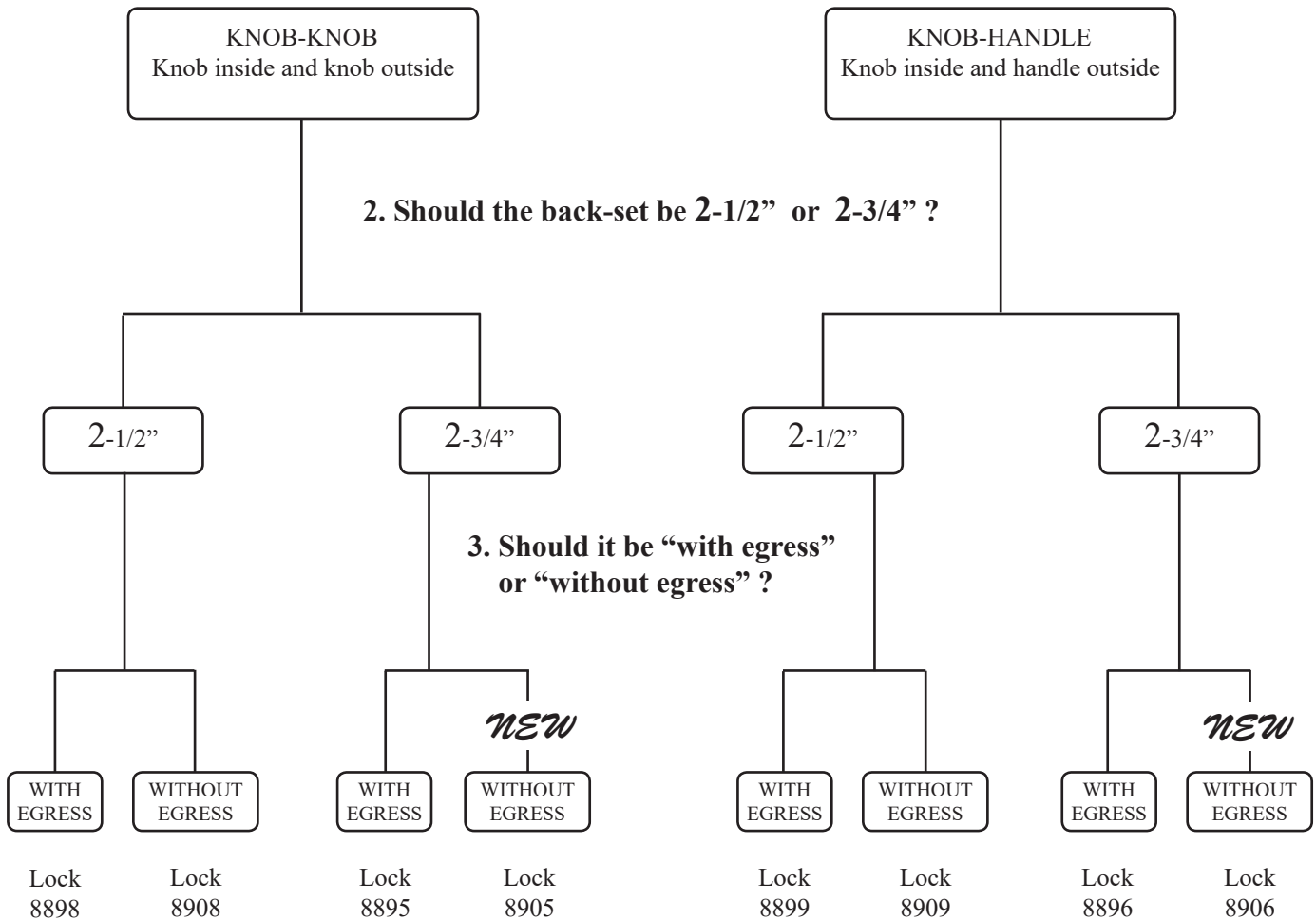

See page 7 for explanation of "Egress" vs. "Non-Egress"

See pages 22-24 on how to choose a full door set with lock, knobs and trim

# Locks Without Egress vs. Locks With Egress

## Without Egress

- Opening a closed door from inside with the deadbolt engaged: First disengage deadbolt with the thumb-turn, then turn doorknob.
- Stepping outside: Closed door remains unlocked until you use the key (unless you've pushed the stop-button in the lock's front/face plate).
- Will not lock yourself out inadvertently.
- Preferable in ordinary circumstances.

## With Egress

- Opening a closed door from inside with the deadbolt engaged: Can be opened with a single action by turning the doorknob.
- Stepping outside: Closed door remains locked until you use the key (unless you've pushed the release-button in the lock's front/face plate).
- Take a key when stepping out.
- Preferable in an emergency, when you need to rush out the door.

"With egress" adds a level of security; however it raises the possibility of locking oneself out - otherwise both types of locks are the same

## Without Egress

## With Egress

Dependable Security	Yes	Yes
Single Action Exit	No	Yes
Closed door remains unlocked after exit	Yes	No
Push release-button for re-entry without a key	No	Yes
Works with all trim options	Yes	Yes



**8841-20** Swivel spindle  
Length: 3 1/4", width: 9/32" (7 mm), 3/8-20 thread  
Steel, zinc plated



**8846-16** Swivel spindle 3/8-16 thread  
**8846-20** Swivel spindle 3/8-20 thread  
Length: 3 1/2", Width: 9/32" (7 mm)  
Steel, zinc plated  
*Available in two TPI specifications*



**8843-20** Swivel spindle  
Length: 3 1/2", width: 5/16" (8 mm), 3/8-20 thread  
Steel, zinc plated

**Swivel spindles for privacy function**

The two halves of the spindle rotate independently of each other - do not tighten them together all the way



**8837-20** Swivel spindle  
Length: 3 3/4", width: 9/32" (7 mm), 3/8-20 thread  
Steel, zinc plated



**8838-20** Swivel spindle 9/32" (7mm) wide  
**8778-20** Swivel spindle 5/16" (8 mm) wide  
Length: 4", thread: 3/8 - 20, zinc plated steel  
Available in two widths



**8770-20** swivel spindle 9/32" (7mm) wide  
Length: 4 1/2", thread: 3/8 - 20, zinc plated steel  
*A longer spindle for thicker doors*



**8842-20** Straight spindle  
Length: 3 1/4", width: 9/32" (7mm), 3/8-20 thread  
Steel, zinc plated



**8847-16** Straight spindle 3/8-16 thread  
**8850-20** Straight spindle 3/8-20 thread  
Length: 3 1/2", width: 9/32" (7 mm)  
Steel, zinc plated  
*Available in two TPI specifications*



**8844-20** Straight spindle  
Length: 3 1/2", width: 5/16" (8 mm), 3/8-20 thread  
Steel, zinc plated

**Straight spindles for passage function**



**8839-20** Straight spindle 9/32" (7mm) wide  
**8777-20** Straight spindle 5/16" (8 mm) wide  
Length: 4", thread: 3/8 - 20, zinc plated steel  
Available in two widths

*For old doorknobs with square holes*



**8774** Plain straight spindle  
Length: 4 1/2", width: 9/32" (7mm), zinc plated steel  
Door thickness range: from 1 3/8" to 2 1/2"  
*Plain unthreaded spindle with 5 threaded holes for screws  
Comes with two 10-24 X 3/8" set screws (shown below)*

*Sold in  
bags  
of 20*



**8775** set screws for plain spindles  
10-24 thread, 3/8" long  
Oval head, Phillips, brass screws  
*For old doorknobs with square holes  
and plain spindles  
(like #8874 shown above)  
Sold in bags of 20*

Dummy spindles



**8848-16** 1 3/16" tall 3/8-16 thread  
**8849-20** 15/16" tall 3/8-20 thread  
**8849-20-L** 1 1/2" tall 3/8-20 thread  
 Width: 9/32" (7 mm)  
 1" base dia.  
 Steel, zinc plated  
 Dummy spindles for rigid knobs  
 Available in two TPI specifications  
 Sold in pairs

Sold in pairs



Closest spindle for regular doors

**8833-PB** polished brass  
**8833-PL** lacquered polished brass  
**8833-PN** polished nickel  
**8833-BN** brushed nickel  
**8833-OB** oil rubbed bronze  
 Spindle length: 2 1/2" , 3/8"-20 thread  
 Spindle width: 9/32" (7mm)  
 Plate 1 1/2" dia.  
 Solid brass and steel parts

Closest spindles with crescent knobs and small plain plates  
 Can substitute other roses for the plate if so desired



Closest spindle for thicker doors

**8834-PB** polished brass  
**8834-PL** lacquered polished brass  
**8834-PN** polished nickel  
**8834-BN** brushed nickel  
**8834-OB** oil rubbed bronze  
 Spindle length: 3" , 3/8"-20 thread  
 Spindle width: 9/32" (7mm)  
 Plate 1 1/2" dia.  
 Solid brass and steel parts



Thumb turn - can be removed from plate if needed for other applications.

**8832-PB** polished brass  
**8832-PL** lacquered polished brass  
**8832-PN** polished nickel  
**8832-BN** brushed nickel  
**8832-OB** oil rubbed bronze  
 Spindle: 3/16" wide , 1 1/4" long  
 Oval plate: 1 3/16" X 1 3/4"  
 Solid brass  
 Crescent thumb turn for mortise lock deadbolt with stamped raised oval plate



Includes removable plug for center hole. Turn with spindle to be kept away

**8831-PB** polished brass  
**8831-OB** oil rubbed bronze  
**8831-PN** polished nickel  
 Oval plate 1 3/4" X 1 3/16"  
 Diameter of plug hole 3/8"  
 Crescent thumb turn with 3/16" square spindle  
 Solid brass  
 Outside release kit for locks and deadbolts



Sold in pairs

**8776** Spindle converters  
 7 mm inside , 8 mm outside width  
 5/16" long  
 Steel , zinc plated  
 2 shorter sleeves  
 Use with knob-knob mortise lock

Converters enable a 9/32" spindle to operate snugly in a 5/16" hub



Sold each

**8703** Spindle converter  
 7 mm inside , 8 mm outside width  
 5/8" long  
 Steel , zinc plated  
 1 longer sleeve  
 Use with knob-handle mortise lock



Nut for spindles

**8662** Nut  
 3/8 - 20 TPI  
 5/8" dia. , 3/16" high  
 Steel, zinc plated  
 For optional use with split doorknob spindles.  
 By tightening the nut against the lock's hub it helps set the spindle in the lock

#8662 nut and #8703 converter sleeve shown on #8845-20-N split spindle for a single doorknob application



Split spindle

**8845-20-N** 2-1/2" long (longer)  
**8845-20-X** 2-1/4" long (shorter)  
 Width: 9/32" (7 mm) , 3/8-20 thread  
 Steel, zinc plated  
 Split spindle without screw or holes



Split spindles for doorknobs with threaded round holes or square holes  
 Used in conjunction with #8859 exterior trim with handle

Split spindle

**8845-16** 3/8-16 thread  
**8845-20** 3/8-20 thread  
 Length: 2 1/2" , width: 9/32" (7 mm)  
 Steel, zinc plated  
 Split spindles with screw and 3 holes  
 Available in two TPI specifications



Half-spindles and split spindles  
 For door locks and latches operated by knob on one side only



Half spindle

**8773-20** 9/32" (7 mm) wide  
**8772-20** 5/16" (8 mm) wide  
 Length: 2 3/8" , thread: 3/8 - 20  
 Steel, zinc plated  
 Half spindle - available in 2 widths

Half-spindles for doorknobs used in conjunction with #8857 and #8858 exterior trim with handle



Sectional outside trim

Exterior entrance door plates with handles and thumb pieces

For mortise locks with Knob-Handle function  
Come with square cylinder collars



- 8859-PB** polished brass
- 8859-OB** oil rubbed bronze
- 8859-PL** lacquered polished brass
- 8859-BN** brushed nickel
- 8859-PN** polished nickel

Upper trim plate: 2 3/4" X 2 3/4"  
Lower trim plate: 2 3/16" X 2 3/16"  
Handle center to center holes: 6 9/16"  
Handle projection: 2 3/4"  
Cylinder collar: 2 3/4" X 2 3/4"  
Solid brass  
*Handle installed with machine screws from inside.*  
*Includes round brass caps to cover heads of screws.*  
*(Keyway cylinder sold separately)*

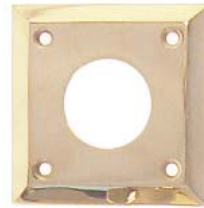

- 8858-PB** polished brass
- 8858-OB** oil rubbed bronze
- 8858-PL** lacquered polished brass
- 8858-BN** brushed nickel
- 8858-PN** polished nickel

Upper trim plate: 2 3/4" X 3 3/4"  
Lower trim plate: 2 3/16" X 2 3/16"  
Handle center to center holes: 6 9/16"  
Handle projection: 2 3/4"  
Cylinder collar: 2 3/4" X 2 3/4"  
Solid brass  
*Handle installed with machine screws from inside.*  
*Includes round brass caps to cover heads of screws.*  
*(Keyway cylinder sold separately)*

*This plate enables using a half-spindle with the knob on the inside of the door*



- 8860-PB** polished brass
- 8860-OB** oil rubbed bronze
- 8860-PL** lacquered pol. brass
- 8860-BN** brushed nickel
- 8860-PN** polished nickel

Collar plate: 2 3/4" X 2 3/4"  
Cylinder hole dia.: 1 3/16" (1.185")  
Solid brass  
*Square collar plate for keyway cylinder can be ordered by themselves*  
*(Keyway cylinder sold separately)*



- 8856-PB** polished brass
- 8856-OB** oil rubbed bronze
- 8856-PL** lacquered brass
- 8856-BN** brushed nickel
- 8856-PN** polished nickel

*Screws, threaded washers and decorative brass caps used to install door handles can be ordered by themselves*

Non-sectional outside trim  
 Exterior entrance door plate  
 with handle and thumb piece  
 For mortise locks with Knob-Handle function

8857  
 Door  
 plate  
 with  
 handle

*Trim plate 8855 corresponds to  
 upper plate of door handle 8857*

*The long plate  
 enables using  
 a half-spindle  
 with the knob  
 on the other  
 side of the door*



**8855-PB** polished brass  
**8855-PL** lacquered brass  
**8855-PN** polished nickel  
**8855-BN** brushed nickel  
**8855-OB** oil rubbed bronze  
 2 3/4" wide , 8 3/4" high  
 2 1/4" spacing (hub to thumb turn)  
 Forged brass  
 Thumb turn with 3/16" spindle  
 With doorknob hub and thumb turn

*This plate is used for entry door sets  
 with knob-handle function (pairing  
 with handles 8857, 8858, 8859)*

**8857-PB** polished brass  
**8857-OB** oil rubbed bronze  
**8857-PL** lacquered brass  
**8857-PN** polished nickel  
**8857-BN** brushed nickel

Upper trim plate: 2 3/4" X 8 3/4"  
 Lower trim plate: 2 3/16" X 2 3/16"  
 Handle center to center holes: 6 9/16"  
 Handle projection: 2 3/4"  
 Solid brass

*Handle installed with machine screws from inside  
 Includes round brass caps to cover heads of screws  
 (Keyway cylinder sold separately)*

2 3/4" X 8 3/4"  
 Forged brass plain door trim  
 With hub and thumb turn

Large plate for entrance door mortise lock sets

**EXTERIOR ENTRY DOOR TRIM WITH HANDLES AND THUMB PIECES**

For door sets with locks no. 96, 99, 06, 09

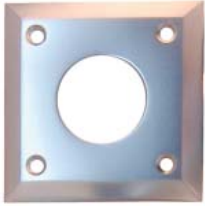

8859  
Sectional exterior door trim  
Shorter upper plate, handle,  
Lower plate, cylinder collar

8858  
Sectional exterior door trim  
Medium upper plate, handle,  
Lower plate, cylinder collar

8857  
Non-sectional exterior door trim  
Longer upper plate, handle,  
Lower plate  
*Single escutcheon plate*

Three entrance door handles. The handles are the same in all three, but they differ in the length of the upper plates. Available in 5 finishes: polished brass, lacquered polished brass, oil-rubbed bronze, polished nickel and brushed (satin) nickel. Combined with different knobs, roses, plates and locks, they offer a large variety of complete door trim sets.

See next two pages for details and specifications





For doors with standard  
1-3/4" thickness ( $\pm 1/8"$ )

- 8900-PB** polished brass
  - 8900-PL** lacquered brass
  - 8900-OB** oil rubbed bronze
  - 8900-PN** polished nickel
  - 8900-BN** brushed nickel
- Cylinder length: 1 1/8" (29 mm)  
Cylinder diameter: 1 1/8" (29 mm)  
Brass face  
Comes with 3 keys

Cylinders can be ordered by themselves when extra ones are needed



For 2" thick doors ( $\pm 1/8"$ )

- 8901-PB** polished brass
  - 8901-PL** lacquered brass
  - 8901-OB** oil rubbed bronze
  - 8901-BN** brushed nickel
  - 8901-PN** polished nickel
- Cylinder length: 1 1/4" (32 mm)  
Cylinder diameter: 1 1/8" (29 mm)  
Brass face  
Comes with 3 keys

Longer keyway cylinders for thicker doors



For 2-1/4" thick doors ( $\pm 1/8"$ )

- 8902-PB** polished brass
  - 8902-PL** lacquered brass
  - 8902-OB** oil rubbed bronze
  - 8902-BN** brushed nickel
  - 8902-PN** polished nickel
- Cylinder length: 1 3/8" (35 mm)  
Cylinder diameter: 1 1/8" (29 mm)  
Brass face  
Comes with 3 keys

Adds 3/16" to the distance of  
the cylinder from the door or  
from the plate



- 8926-PB** polished brass
  - 8926-OB** oil rubbed bronze
- Top outside diameter: 1 9/16"  
Bottom outside diameter: 1 3/4"  
Top inside diameter: 1 3/8"  
Bottom inside diameter: 1 3/16"  
Height: 7/16"  
Solid brass  
Round collar for keyway cylinder  
(Keyway cylinder sold separately)



Collar shown with  
keyway cylinder



8879

- 8915-PB** polished brass
  - 8915-PL** lacquered brass
  - 8915-OB** oil rubbed bronze
  - 8915-BN** brushed nickel
  - 8915-PN** polished nickel
- Kit includes #8879 strike plate,  
1 1/4" long keyway cylinder,  
and a 4" spindle  
Sold with lock set

For knob-knob and  
knob-handle sets

Medium thick door kit  
For 2" thick doors ( $\pm 1/8"$ )



8901

8778-20



For knob-knob lock

Or

8845-20-N



And

8845-20-X



For knob-handle lock

- 8915-PB-S** polished brass
  - 8915-PL-S** lacquered brass
  - 8915-OB-S** oil rubbed bronze
  - 8915-BN-S** brushed nickel
  - 8915-PN-S** polished nickel
- Kit includes #8879 strike plate,  
1 1/4" long keyway cylinder,  
and a 4" spindle  
Stand-alone, sold by itself

### Kits to adapt mortise lock sets for thicker doors

Order the lock-set and the appropriate thick door kit

Thick door kit  
For 2-1/4" thick doors ( $\pm 1/8"$ )



8878



8902

8778-20



8770-20



And

For knob-knob lock

Or

8845-20-N



For knob-handle lock

- 8916-PB** polished brass
  - 8916-PL** lacquered brass
  - 8916-OB** oil rubbed bronze
  - 8916-BN** brushed nickel
  - 8916-PN** polished nickel
- Kit includes #8878 strike plate,  
1 3/8" long keyway cylinder,  
and 2 spindles: 4" and 4 1/2"  
Sold with lock set

For knob-knob and  
knob-handle sets

- 8916-PB-S** polished brass
  - 8916-PL-S** lacquered brass
  - 8916-OB-S** oil rubbed bronze
  - 8916-BN-S** brushed nickel
  - 8916-PN-S** polished nickel
- Kit includes #8878 strike plate,  
1 3/8" long keyway cylinder,  
and 2 spindles: 4" and 4 1/2"  
Stand-alone, sold by itself

*Octagonal glass knobs*



- 8851-PB** polished brass base
  - 8851-PL** lacquered polished brass base
  - 8851-PN** polished nickel base
  - 8851-OB** oil rubbed bronze base
  - 8851-BN** brushed nickel base
- Clear glass knob 2 1/4" dia.  
 Pressed glass knob with solid brass base

**CLEAR GLASS DOORKNOBS**

Base bottom dia. (part that goes into hub): .625" (5/8")  
 Rim of brass base folds over base of glass knob for secure grip  
 Silver under glass amplifies reflected light to show beautiful facets  
 Set includes 2 knobs on a spindle and an Allen key for set screws  
 Steel spindle 3-1/2" long, 9/32" (7 mm) wide, with 3/8-20 thread

*Fluted glass knobs*



- 8852-PB** polished brass base
  - 8852-PL** lacquered polished brass base
  - 8852-PN** polished nickel base
  - 8852-OB** oil rubbed bronze base
  - 8852-BN** brushed nickel base
- Clear glass knob 2" dia.  
 Pressed glass knob with solid brass base

*Round glass knobs*



- 8853-PB** polished brass base
  - 8853-PL** lacquered polished brass base
  - 8853-PN** polished nickel base
  - 8853-OB** oil rubbed bronze base
  - 8853-BN** brushed nickel base
- Clear glass knob 2" dia.  
 Pressed glass knob with solid brass base

*Plain*



- 8746-PB** polished brass
  - 8746-PL** lacquered polished brass
  - 8746-PN** polished nickel
  - 8746-BN** brushed nickel
  - 8746-OB** oil rubbed bronze
- 2 1/4" dia. knobs  
 Lower base dia.: 5/8"  
 Solid brass  
 Hollow core knobs

**SOLID BRASS HOLLOW CORE OLD-STYLE DOORKNOBS**

Base bottom dia. (part that goes into hub): .625" (5/8")  
 Set includes 2 knobs on a spindle and an Allen key for set screws  
 Steel spindle 4" long, 9/32" (7 mm) wide, with 3/8-20 thread

*Embossed lines pattern*



- 8745-PB** polished brass
  - 8745-PL** lacquered polished brass
  - 8745-PN** polished nickel
  - 8745-BN** brushed nickel
  - 8745-OB** oil rubbed bronze
- 2 1/4" dia. knobs  
 Lower base dia.: 5/8"  
 Solid brass  
 Hollow core knobs

*Plain*



- 8755-PB** polished brass
- 8755-PL** lacquered polished brass
- 8755-PN** polished nickel
- 8755-BN** brushed nickel
- 8755-OB** oil rubbed bronze

Solid brass knob 2 1/4" dia.  
Lower base dia.: 5/8"  
*Solid-core*

*Embossed lines pattern*



- 8754-PB** polished brass
- 8754-PL** lacquered polished brass
- 8754-PN** polished nickel
- 8754-BN** brushed nickel
- 8754-OB** oil rubbed bronze

Solid brass knob 2 1/4" dia.  
Lower base dia.: 5/8"  
*Solid-core*



**SOLID CORE BRASS DOORKNOBS**

Knobs are forged solid, not hollow, one-piece brass  
Base bottom dia. (part that goes into hub): .625" (5/8")  
Set includes 2 knobs on a spindle and an Allen key for set screws  
Steel spindle 4" long, 9/32" (7 mm) wide, with 3/8-20 thread

*Ornate pattern*



- 8752-PB** polished brass
- 8752-PL** lacquered polished brass
- 8752-PN** polished nickel
- 8752-BN** brushed nickel
- 8752-OB** oil rubbed bronze

Solid brass knob 2 1/4" dia.  
Lower base dia.: 5/8"  
*Solid-core*

*Egg & dart pattern*



- 8753-PB** polished brass
- 8753-PL** lacquered polished brass
- 8753-PN** polished nickel
- 8753-BN** brushed nickel
- 8753-OB** oil rubbed bronze

Solid brass knob 2 1/4" dia.  
Lower base dia.: 5/8"  
*Solid-core*

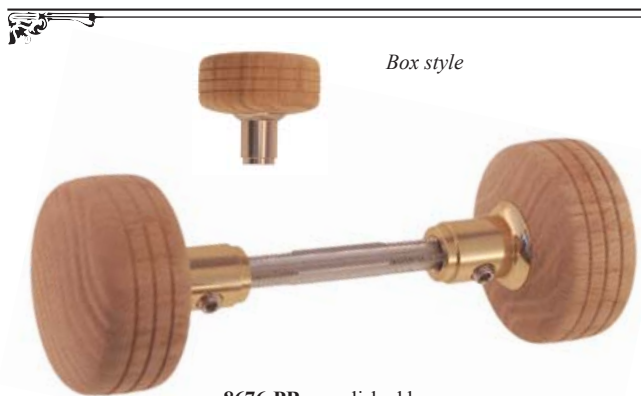

Box style

- 8676-PB** polished brass
- 8676-PL** lacquered brass
- 8676-PN** polished nickel
- 8676-BN** brushed nickel
- 8676-OB** oil rubbed bronze

Can be used with any rose or plate in the catalog

2 1/4" dia.  
 Lower base dia.: 5/8"  
 For hubs with diameter from 5/8" to 3/4"  
 Spindle: 4" long, 9/32" (7mm) wide  
 Red oak knobs with solid brass bases  
 Sold in pairs with a steel spindle  
 Box style

Wood rose for door knob



- 8677**
- 2 1/8" dia.
- 3/4" hub dia.
- Red oak
- Red oak door roses
- Can be used with either of the wood knobs

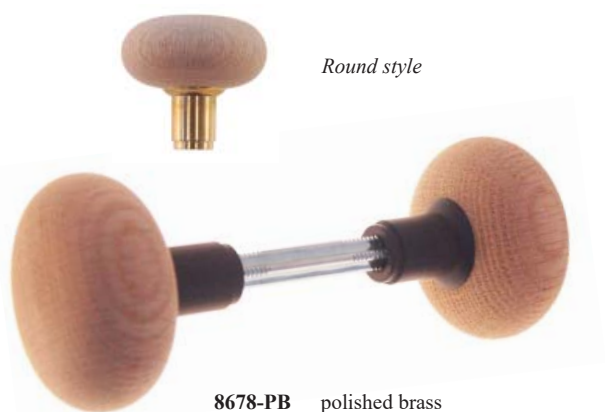

Round style

- 8678-PB** polished brass
- 8678-PL** lacquered brass
- 8678-PN** polished nickel
- 8678-BN** brushed nickel
- 8678-OB** oil rubbed bronze

Can be used with any rose or plate in the catalog

2 1/4" dia.  
 Lower base dia.: 5/8"  
 For hubs with diameter from 11/16" to 3/4"  
 Spindle: 4" long, 9/32" (7mm) wide  
 Red oak knobs with solid brass bases  
 Sold in pairs with a steel spindle  
 Round style



This plate can also be used for entry door sets with knob-handle function (pairing with handles 8857, 8858, 8859)

- 8760-PB** polished brass
- 8760-PL** lacquered brass
- 8760-PN** polished nickel
- 8760-BN** brushed nickel
- 8760-OB** oil rubbed bronze

3" wide, 10" high  
 2 1/4" spacing (hub to thumb turn)  
 Solid brass  
 With doorknob hub and thumb turn

3" X 10"  
 Wrought brass plain door trim  
 2 plate functions

Large complementary plates for entrance door mortise lock sets



- 8761-PB** polished brass
- 8761-PL** lacquered brass
- 8761-PN** polished nickel
- 8761-BN** brushed nickel
- 8761-OB** oil rubbed bronze

3" wide, 10" high  
 3 7/16" (3.438") C to C spacing  
 Solid brass  
 For doorknob and keyway cylinder (Cylinder sold separately)

*This plate can also be used for entry door sets with knob-handle function (pairing with handles 8857, 8858, 8859)*



**8868-PB** polished brass  
**8868-PL** lacquered brass  
**8868-PN** polished nickel  
**8868-BN** brushed nickel  
**8868-OB** oil rubbed bronze  
 2 1/2" wide, 8" high  
 2 1/4" spacing (hub to thumb turn)  
 Forged brass  
 Thumb turn with 3/16" spindle  
 With doorknob hub and thumb turn

*This plate can be used with interior door mortise locks operated by skeleton keys*



**8865-PB** polished brass  
**8865-PL** lacquered brass  
**8865-PN** polished nickel  
**8865-BN** brushed nickel  
**8865-OB** oil rubbed bronze  
 2 1/2" wide, 8" high  
 2 1/4" hub to keyhole spacing  
 Forged brass  
 With doorknob hub & keyhole

2 1/2" X 8"

Forged brass plain door trim  
 4 plate functions

Large plates for mortise lock door sets

Large complementary plates for entrance door mortise lock sets



**8869-PB** polished brass  
**8869-PL** lacquered brass  
**8869-PN** polished nickel  
**8869-BN** brushed nickel  
**8869-OB** oil rubbed bronze  
 2 1/2" wide, 8" high  
 3 7/16" (3.438") C to C spacing  
 Forged brass  
 For doorknob and keyway cylinder  
 (Cylinder sold separately)

**8862-PB** polished brass  
**8862-PL** lacquered brass  
**8862-PN** polished nickel  
**8862-BN** brushed nickel  
**8862-OB** oil rubbed bronze  
 2 1/2" wide, 8" high  
 Forged brass  
 With doorknob hub

*This plate can be used with interior door mortise locks or latches*



**8864-PB** polished brass  
**8864-PL** lacquered brass  
**8864-PN** polished nickel  
**8864-BN** brushed nickel  
**8864-OB** oil rubbed bronze  
 2 1/4" wide, 7" high  
 Wrought brass  
 With doorknob hub

**8866-PB** polished brass  
**8866-PL** lacquered brass  
**8866-PN** polished nickel  
**8866-BN** brushed nickel  
**8866-OB** oil rubbed bronze  
 2 1/4" wide, 7" high  
 2 1/4" spacing (hub to keyhole)  
 Wrought brass  
 With doorknob hub & keyhole

**8764-B-PB** polished brass  
**8764-B-PL** lacquered brass  
**8764-B-PN** polished nickel  
**8764-B-BN** brushed nickel  
**8764-B-OB** oil rubbed bronze  
 2 1/2" wide, 6 7/8" high  
 Wrought brass  
 With doorknob hub

**8764-K-PB** polished brass  
**8764-K-PL** lacquered brass  
**8764-K-PN** polished nickel  
**8764-K-BN** brushed nickel  
**8764-K-OB** oil rubbed bronze  
 2 1/2" wide, 6 7/8" high  
 2 1/4" spacing (hub to keyhole)  
 Wrought brass  
 With doorknob hub and keyhole

2 1/4" X 7"  
 Wrought brass plain door trim plates  
 4 plate functions

2 1/2" X 6 7/8"  
 Wrought brass trim plates with indented line pattern  
 4 plate functions



**8867-PB** polished brass  
**8867-PL** lacquered brass  
**8867-PN** polished nickel  
**8867-BN** brushed nickel  
**8867-OB** oil rubbed bronze  
 2 1/4" X 7"  
 2 1/4" spacing (hub to thumb turn)  
 Wrought brass  
 Thumb turn with 3/16" spindle  
 With doorknob hub and thumb turn

**8863-PB** polished brass  
**8863-PL** lacquered brass  
**8863-PN** polished nickel  
**8863-BN** brushed nickel  
**8863-OB** oil rubbed bronze  
 2 1/4" wide, 7" high  
 3 7/16" (3.438") C to C spacing  
 Wrought brass  
 For doorknob and keyway cylinder  
 (Cylinder sold separately)

**8734-PB** polished brass  
**8734-PL** lacquered brass  
**8734-PN** polished nickel  
**8734-BN** brushed nickel  
**8734-OB** oil rubbed bronze  
 2 1/2" wide, 6 7/8" high  
 2 1/4" spacing (hub to thumb turn)  
 Heavy gauge wrought brass  
 Thumb turn with 3/16" spindle  
 With doorknob hub and thumb-turn

**8733-PB** polished brass  
**8733-PL** lacquered brass  
**8733-PN** polished nickel  
**8733-BN** brushed nickel  
**8733-OB** oil rubbed bronze  
 2 1/2" wide, 6 7/8" high  
 3 7/16" (3.438") spacing  
 Wrought brass  
 For doorknob and keyway cylinder  
 Cylinder sold separately



**8767-B-PB** polished brass  
**8767-B-PL** lacquered brass  
**8767-B-PN** polished nickel  
**8767-B-BN** brushed nickel  
**8767-B-OB** oil rubbed bronze  
 2 1/2" wide, 7" high  
 Wrought brass  
 With doorknob hub

**8767-K-PB** polished brass  
**8767-K-PL** lacquered brass  
**8767-K-PN** polished nickel  
**8767-K-BN** brushed nickel  
**8767-K-OB** oil rubbed bronze  
 2 1/2" wide, 7" high  
 2 1/4" spacing (hub to keyhole)  
 Wrought brass  
 With doorknob hub and keyhole

2 1/2" X 7"

Wrought brass trim plates with egg & dart pattern  
 4 plate functions



**8768-PB** polished brass  
**8768-PL** lacquered brass  
**8768-PN** polished nickel  
**8768-BN** brushed nickel  
**8768-OB** oil rubbed bronze  
 2 1/2" wide, 7" high  
 2 1/4" spacing (hub to thumb turn)  
 Wrought brass  
 Thumb turn with 3/16" spindle  
 With doorknob hub and thumb-turn

**8769-PB** polished brass  
**8769-PL** lacquered brass  
**8769-PN** polished nickel  
**8769-BN** brushed nickel  
**8769-OB** oil rubbed bronze  
 2 1/2" wide, 7" high  
 3 7/16" (3.438") spacing  
 Wrought brass  
 For doorknob and keyway cylinder  
 Cylinder sold separately



2 3/8" X 8 1/2"



**8762-B-PB** polished brass  
**8762-B-PL** lacquered brass  
**8762-B-PN** polished nickel  
**8762-B-BN** brushed nickel  
**8762-B-OB** oil rubbed bronze  
 2 3/8" wide  
 8 1/2" high  
 (2 3/4" at widest)  
 Wrought brass  
 With doorknob hub

**8762-K-PB** polished brass  
**8762-K-PL** lacquered brass  
**8762-K-PN** polished nickel  
**8762-K-BN** brushed nickel  
**8762-K-OB** oil rubbed bronze  
 2 3/8" wide, 8 1/2" high  
 (2 3/4" at widest)  
 2 1/4" spacing (hub to keyhole)  
 Wrought brass  
 With doorknob hub and keyhole

Wrought brass trim plates with ornate patterns  
 2 plate functions



2 3/8" X 7 5/8"



**8763-B-PB** polished brass  
**8763-B-PL** lacquered brass  
**8763-B-PN** polished nickel  
**8763-B-BN** brushed nickel  
**8763-B-OB** oil rubbed bronze  
 2 3/8" wide  
 7 5/8" high  
 Wrought brass  
 With doorknob hub

**8763-K-PB** polished brass  
**8763-K-PL** lacquered brass  
**8763-K-PN** polished nickel  
**8763-K-BN** brushed nickel  
**8763-K-OB** oil rubbed bronze  
 2 3/8" wide, 7 5/8" high  
 2 1/4" spacing (hub to keyhole)  
 Wrought brass  
 With doorknob hub and keyhole



**8677**  
 Diameter: 2 1/8"  
 Hub diameter: 3/4"  
 Center to center: 1 1/2"  
 Red oak  
*Red oak door roses*

Wood doorknob rose



**8740-PB** polished brass  
**8740-PL** lacquered brass  
**8740-PN** polished nickel  
**8740-BN** brushed nickel  
**8740-OB** oil rubbed bronze  
 Diameter: 2"  
 Hub diameter: 3/4"  
 Forged brass  
*Plain*



**8870-PB** polished brass  
**8870-PL** lacquered polished brass  
**8870-PN** polished nickel  
**8870-BN** brushed nickel  
**8870-OB** oil rubbed bronze  
 Diameter: 2"  
 Hub diameter: 3/4"  
 Stamped brass  
*Traditional design with 3 holes for screws*

2" diameter

Wrought (stamped) brass doorknob roses



**8741-PB** polished brass  
**8741-PL** lacquered brass  
**8741-PN** polished nickel  
**8741-BN** brushed nickel  
**8741-OB** oil rubbed bronze  
 Diameter: 2 1/4"  
 Hub diameter: 3/4"  
 Center to center: 1 3/4"  
 Forged brass  
*Indented lines pattern*

Forged brass doorknob roses



**8871-PB** polished brass  
**8871-PL** lacquered polished brass  
**8871-PN** polished nickel  
**8871-BN** brushed nickel  
**8871-OB** oil rubbed bronze  
 Diameter: 2 1/4"  
 Hub diameter: 5/8"  
 Stamped brass  
*Traditional design with 3 holes for screws*

2 1/4" diameter



**8742-PB** polished brass  
**8742-PL** lacquered brass  
**8742-PN** polished nickel  
**8742-BN** brushed nickel  
**8742-OB** oil rubbed bronze  
 Diameter: 2 1/4"  
 Hub diameter: 11/16"  
 Forged brass  
*Embossed lines pattern*



**8876-PB** polished brass  
**8876-PN** polished nickel  
**8876-BN** brushed nickel  
**8876-OB** oil rubbed bronze  
**8876-PL** lacquered brass  
 Diameter: 2 1/2"  
 Hub diameter: 11/16"  
 Center to center: 1 1/2"  
 Forged brass  
*Hexagonal doorknob rose*

Forged brass doorknob rose



**8743-PB** polished brass  
**8743-PL** lacquered brass  
**8743-PN** polished nickel  
**8743-BN** brushed nickel  
**8743-OB** oil rubbed bronze  
 Diameter: 2 3/16"  
 Hub diameter: 3/4"  
 Center to center: 1 11/16"  
 Forged brass  
*Floral pattern*





**8873-A-PB** polished brass  
**8873-A-PL** lacquered polished brass  
**8873-A-PN** polished nickel  
**8873-A-BN** brushed nickel  
**8873-A-OB** oil rubbed bronze  
 Diameter: 2 3/4"  
 Hub dia.: 5/8"  
 Center to center: 1 5/8"  
 Forged brass  
 Includes wood screws  
*Privacy function*

Privacy function



*With threaded shanks*

**8873-C-PB** polished brass  
**8873-C-PL** lacquered polished brass  
**8873-C-PN** polished nickel  
**8873-C-BN** brushed nickel  
**8873-C-OB** oil rubbed bronze  
 Diameter: 2 3/4"  
 Hub dia.: 5/8"  
 Center to center: 1 5/8"  
 Forged brass  
 Includes machine screws  
*Privacy function*

Solid brass forged doorknob roses  
 2 3/4" diameter  
 5/8" hub dia.

Complementary roses for privacy or passage function  
 Can be used on standard pre-drilled doors



**8873-B-PB** polished brass  
**8873-B-PL** lacquered polished brass  
**8873-B-PN** polished nickel  
**8873-B-BN** brushed nickel  
**8873-B-OB** oil rubbed bronze  
 Diameter: 2 3/4"  
 Hub dia.: 5/8"  
 Center to center: 1 5/8"  
 Forged brass  
 Includes wood screws  
*Passage function*

Passage function



*With threaded shanks*

**8873-D-PB** polished brass  
**8873-D-PL** lacquered polished brass  
**8873-D-PN** polished nickel  
**8873-D-BN** brushed nickel  
**8873-D-OB** oil rubbed bronze  
 Diameter: 2 3/4"  
 Hub dia.: 5/8"  
 Center to center: 1 5/8"  
 Forged brass  
 Includes machine screws  
*Passage function*



**8874-B-PB** polished brass  
**8874-B-PL** lacquered polished brass  
**8874-B-PN** polished nickel  
**8874-B-BN** brushed nickel  
**8874-B-OB** oil rubbed bronze  
 Diameter: 3 1/4"  
 Hub dia.: 5/8"  
 Center to center: 2 9/16"  
 Forged brass  
*Extra large rose*  
*Passage function*

Plain



**8874-A-PB** polished brass  
**8874-A-PL** lacquered polished brass  
**8874-A-PN** polished nickel  
**8874-A-BN** brushed nickel  
**8874-A-OB** oil rubbed bronze  
 Diameter: 3 1/4"  
 Hub dia.: 5/8"  
 Center to center: 2 9/16"  
 Forged brass  
*Extra large rose*  
*Privacy function*

Solid brass forged doorknob roses  
 3 1/4" diameter  
 5/8" hub dia.

For privacy or passage functions  
 Can be used on standard pre-drilled doors



**8875-B-PB** polished brass  
**8875-B-PL** lacquered polished brass  
**8875-B-PN** polished nickel  
**8875-B-BN** brushed nickel  
**8875-B-OB** oil rubbed bronze  
 Diameter: 3 1/4"  
 Hub dia.: 5/8"  
 Center to center: 2 7/8"  
 Forged brass  
*Passage function*

Beaded



**8875-A-PB** polished brass  
**8875-A-PL** lacquered polished brass  
**8875-A-PN** polished nickel  
**8875-A-BN** brushed nickel  
**8875-A-OB** oil rubbed bronze  
 Diameter: 3 1/4"  
 Hub dia.: 5/8"  
 Center to center: 2 7/8"  
 Forged brass  
*Privacy function*



# HOW TO ORDER ENTRY DOOR LOCK SETS

## 1. Select lock:

Knob-Knob  
(K-K lock)

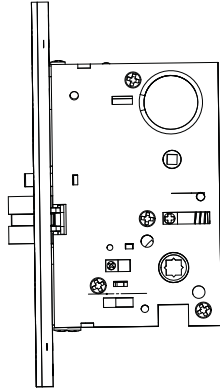

Enter 95  
for lock 8895

2-3/4" backset  
With egress  
Knob-Knob

Enter 98  
for lock 8898

2-1/2" backset  
With egress  
Knob-Knob

*NEW*  
Enter 05  
for lock 8905

2-3/4" backset  
Without egress  
Knob-Knob

Enter 08  
for lock 8908

2-1/2" backset  
Without egress  
Knob-Knob

Knob-Handle  
(K-H lock)

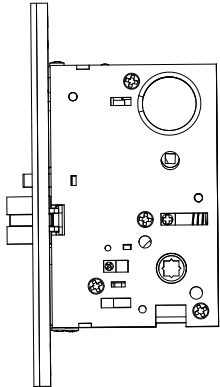

Enter 96  
for lock 8896

2-3/4" backset  
With egress  
Knob-Handle

Enter 99  
for lock 8899

2-1/2" backset  
With egress  
Knob-Handle

*NEW*  
Enter 06  
for lock 8906

2-3/4" backset  
Without egress  
Knob-Handle

Enter 09  
for lock 8909

2-1/2" backset  
Without egress  
Knob-Handle

## 2. Select door knob:



8754  
Solid core brass



8755  
Solid core brass



8752  
Solid core brass



8753  
Solid core brass



8746  
Hollow core brass



8745  
Hollow core brass



8851  
Glass



8852  
Glass



8853  
Glass



### 3. Select the inside trim:

For K-K lock - all plates and all roses.

For K-H lock - the first three, largest plates and all roses



Thumb  
turn



8760 Plain larger    8855 Plain larger    8868 Plain larger    8867 Plain    8734 Indented line    8768 Egg & Dart



8870    8871    8740    8741    8742    8743    8876    8873

### 4. Select the outside trim:

For K-K lock - all plates.

For K-H lock - all handles.



8761 Plain largest    8869 Plain larger    8863 Plain    8733 Indented line    8769 Egg & Dart

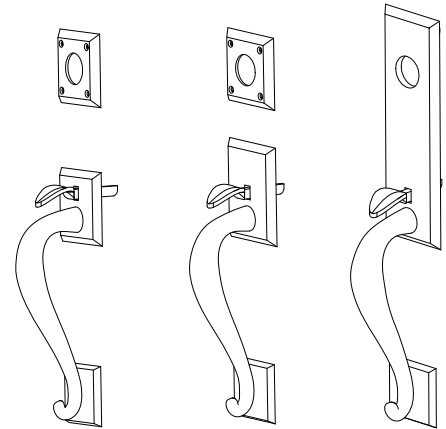

8859 Sectional    8858 Sectional    8857 Non sectional

### 5. Select the finish:

Polished Brass (PB), Lacquered Polished Brass (PL),  
Oil-rubbed Bronze (OB), Polished Nickel (PN), Brushed Nickel (BN)

### 6. Complete stock number format for set:

**[Lock]-[Knob]-[Inside Trim]-[Outside Trim]-[Finish]**

EXTERIOR MORTISE LOCK SETS



2 complementary small plates or large plates

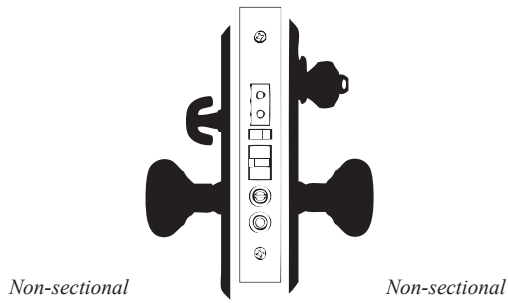

Lock set: knob inside , knob outside  
Plate inside , plate outside

Example: 98-8753-8768-8769-PB  
08-8746-8760-8761-OB  
95-8745-8834-8733-BN  
05-8851-8867-8863-PN

Any rose

Any plate

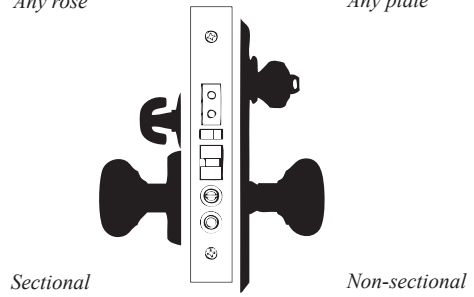

Lock set: knob inside , knob outside  
Rose and thumb-turn inside , plate outside

Example: 98-8754-8742-8733-PB  
08-8851-8873-8869-OB  
95-8746-8740-8863-BN  
05-8745-8741-8733-PN

SPECIFYING ENTRY MORTISE LOCK SETS BY TRIM OPTIONS

Large plate  
8855  
8868  
8760

Handle  
8857

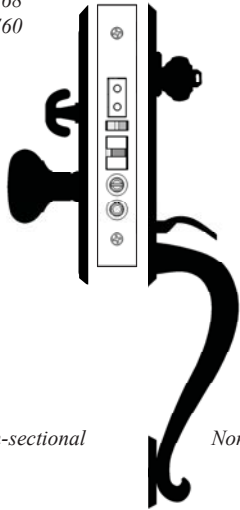

Lock set: knob inside , handle outside  
A plate with a thumb turn inside

Example: 99-8755-8855-8857-PB  
09-8851-8868-8857-OB  
96-8754-8855-8857-BN  
06-8745-8760-8857-BN

Large plate  
8855  
8868  
8760

Handle  
8859  
8858

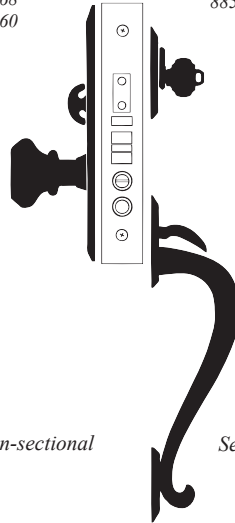

Lock set: knob inside , handle outside  
A plate with a thumb turn inside

Example: 99-8755-8855-8859-PB  
09-8851-8868-8858-OB  
96-8754-8855-8858-BN  
06-8746-8760-8859-BN

Rose  
8873  
8740  
8741  
8742  
8743

Handle  
8859  
8858

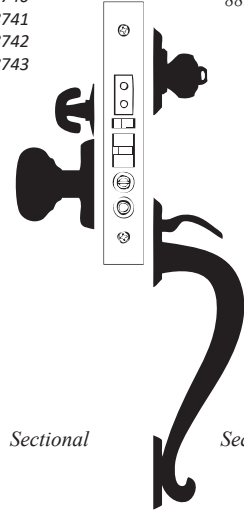

Lock set: knob inside , handle outside  
With rose and thumb turn inside

Example: 99-8752-8743-8859-PB  
09-8852-8876-8858-OB  
96-8746-8740-8859-BN  
06-8745-8742-8858-BN

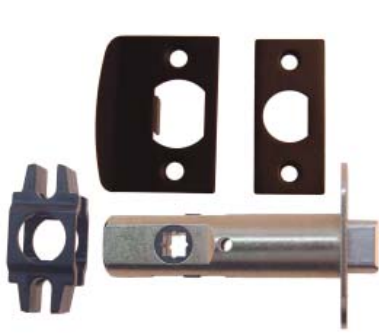

Passage  
latch

- 8891-PB** polished brass
- 8891-PN** polished nickel
- 8891-BN** brushed nickel
- 8891-OB** oil rubbed bronze
- 8891-AB** antique brass
- 8891-AP** antique pewter
- 8891-PL** lacquered brass
- 8891-PC** polished chrome
- 2 3/8" backset
- Face plate 2 1/4" X 1"
- Strike plate 2 1/4" X 1 3/4"

**2 3/8" backset (standard)**

Latches are equipped with  
2-1/8" dia. alignment blocks  
for use in pre-drilled holes



Privacy  
latch

- 8892-A-PB** polished brass
- 8892-A-PN** polished nickel
- 8892-A-OB** oil rubbed bronze
- 8892-A-BN** brushed nickel
- 8892-A-AB** antique brass
- 8892-A-AP** antique pewter
- 8892-A-PL** lacquered brass
- 8892-A-PC** polished chrome
- 2 3/8" backset
- Face plate 2 1/4" X 1"
- Strike plate 2 1/4" X 1 3/4"
- With solid brass privacy pin*

**Tubular door latches for both left & right hand doors**

Die cast with solid brass plates and pins  
Star-shaped hub accepts 7mm and 8mm spindles  
Fit in a 1" diameter hole

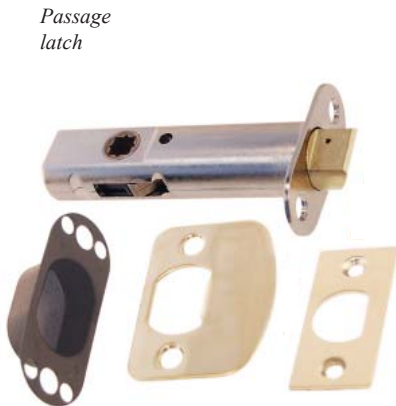

Passage  
latch

- 8903-PB** polished brass
- 8903-PL** lacquered brass
- 8903-PN** polished nickel
- 8903-BN** brushed nickel
- 8903-OB** oil rubbed bronze
- 2 3/4" backset
- Face plate: 2 1/4" X 1"
- Strike plate: 2 1/4" X 1 3/4"

**2 3/4" backset**  
Includes dust box



Privacy  
latch

- 8904A-PB** polished brass
- 8903-PL** lacquered brass
- 8904A-PN** polished nickel
- 8904A-BN** brushed nickel
- 8904A-OB** oil rubbed bronze
- 2 3/4" backset
- Face plate: 2 1/4" X 1"
- Strike plate: 2 1/4" X 1 3/4"
- With solid brass privacy pin*

Guide for choosing complete lock sets in next two pages



## HOW TO ORDER DOOR LATCH SETS

### 1. Select the function of the set:

A - privacy

B - passage

D - dummy

### 2. Select latch (for privacy or passage function only):

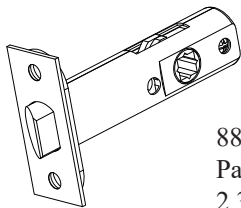

8891  
Passage  
2 3/8" backset

2 3/8" backset  
Standard

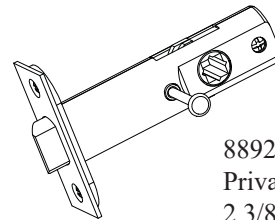

8892  
Privacy  
2 3/8" backset

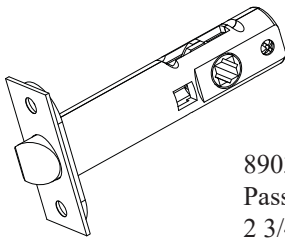

8903  
Passage  
2 3/4" backset

2 3/4" backset

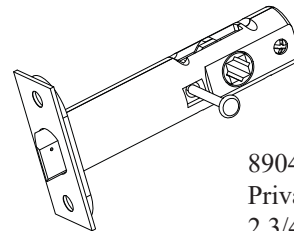

8904  
Privacy  
2 3/4" backset

### 3. Select door knobs:



8746  
Hollow core brass



8745  
Hollow core brass



8752  
Solid core brass



8753  
Solid core brass



8754  
Solid core brass



8755  
Solid core brass



8676  
Oak



8678  
Oak



8851  
Glass



8852  
Glass



8853  
Glass



#### 4. Select the trim:

For privacy function - #8873, #8874, #8875  
(large forged roses with holes for privacy pins)



8873



8874



8875

For passage function and for dummy sets-  
all roses can be used



8873



8874



8875



8677



8740



8741



8742



8743



8876



8873

5. Select the finish: Polished Brass (PB), Lacquered Polished Brass (PL),  
Oil-rubbed Bronze (OB), Polished Nickel (PN), Brushed Nickel (BN)

**Final stock number format for door sets: [Function]-[Latch]-[Knobs]-[Roses]-[Finish]**  
No latch for dummy sets

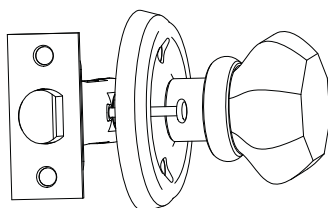

Privacy

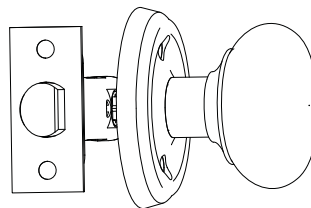

Passage

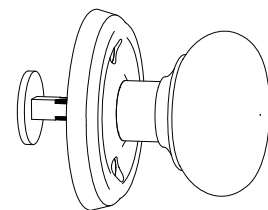

Dummy

*Operated by doorknobs and thumb-turn*



**8919-PB** polished brass  
**8919-OB** oil rubbed bronze  
**8919-PN** polished nickel  
 Spacing: 2 1/4"  
 Unit includes a strike plate and a thumb-turn

*Operated by doorknobs and keys*



**8921-PB** polished brass  
**8921-OB** oil rubbed bronze  
**8921-PN** polished nickel  
 Spacing: 2 3/16"  
 Unit includes a strike plate and 2 keys



**8831-PB** polished brass  
**8831-OB** oil rubbed bronze  
**8831-PN** polished nickel  
 Oval plate 1 3/4" X 1 3/16"  
 Diameter of plug hole 3/8"  
 Crescent thumb turn with 3/16" square spindle  
 Solid brass  
 Outside release kit for locks and deadbolts

**Mortise locks for interior doors.**

Model 8921 - deadbolt is operated by a key  
 Model 8919 - deadbolt is operated by a thumb-turn  
 Dimensions:  
 2 1/2" backset  
 Case: 3 1/8" X 3 5/8" X 9/16"  
 Face plate: 15/16" X 5 1/4" X 1/8" thick  
 Star-shaped doorknob hub accepts two spindle widths:  
 9/32" (7 mm) and 5/16" (8mm)  
 Wrought steel case with steel inner parts  
 Black japanned case  
 Solid brass face plate, latch and bolt in 3 finishes  
 Reversible for right- and left-hand doors

*Authentic old style tumbler locks with japanned cases for interior doors available in 3 face-plate finishes.*

*Add any doorknobs, keyholes, roses and trim plates (sold separately) to form complete door sets.*



*Shown with outside trim*



*Shown with inside trim*



- C8923-PB** polished brass
- C8923-OB** oil rubbed bronze
- C8923-PL** lacquered brass
- C8923-PN** polished nickel
- C8923-BN** brushed nickel

Thumb turn spindle: 3/16"

Rosettes' diameter: 1 5/8"

Door thickness range: 1 3/8" - 1 3/4"

Solid brass

*Operating mechanism by itself - sold each*

*Thumb-turn and emergency release slot unit for operating deadbolt (shown on far right) or mortise lock (shown here). Mortise lock sold separately.*



*Heavy duty tubular deadbolt operated with thumb turn only*

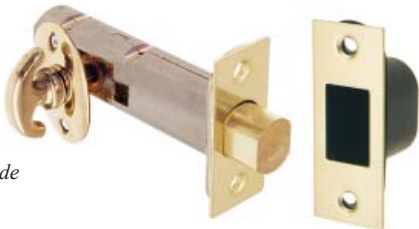

*Room side*

- 8924-PB** polished brass
- 8924-OB** oil rubbed bronze
- 8924-PL** lacquered brass
- 8924-PN** polished nickel
- 8924-BN** brushed nickel

Latch backset: 2 3/8"

Latch tube diameter: 1"

Square hub for thumb turn: 3/16"

Face plate: 1" X 2 1/4"

Strike plate: 1 1/8" X 2 3/4"

Deadbolt made of brass and other materials

Solid brass plates and thumb turn

*Set includes face plate, strike plate, dust box and crescent thumb-turn. For right- and left-hand doors.*

*Heavy duty tubular deadbolt operated with thumb-turn from inside and emergency release slot from outside*

*Room side*



*Hall side*

- 8923-PB** polished brass
- 8923-OB** oil rubbed bronze
- 8923-PL** lacquered brass
- 8923-PN** polished nickel
- 8923-BN** brushed nickel

Latch backset: 2 3/8"

Latch tube diameter: 1"

Square hub for thumb turn: 3/16"

Face plate: 1" X 2 1/4"

Strike plate: 1 1/8" X 2 3/4"

Rosettes' diameter: 1 5/8"

Door thickness range: 1 3/8" - 1 3/4"

Deadbolt made of brass and other materials

Solid brass plates, thumb turn and slot trim parts

*Set includes face plate, strike plate, dust box, crescent thumb-turn and emergency release slot. For right- and left-hand doors.*

*Heavy duty tubular deadbolt operated with thumb-turn from inside and emergency release slot from outside*

*Room side*



*Plug*

*Strike with dust box*

*Hall side*

- 8922-PB** polished brass
- 8922-OB** oil rubbed bronze
- 8922-PN** polished nickel

Latch backset: 2 3/8"

Latch tube diameter: 1"

Square hub for thumb turn: 3/16"

Face plate: 1" X 2 1/4"

Strike plate: 1 1/8" X 2 3/4"

Deadbolt made of brass and other materials

Solid brass plates and thumb turns

*Set includes a thumb-turn on the inside and a plate with a removable plug on the outside. It also includes face plate, strike plate, dust box and an additional thumb-turn for emergency release. For right- and left-hand doors.*



**8885-PB** polished brass  
**8885-PL** lacquered pol. brass  
**8885-PN** polished nickel  
**8885-BN** brushed nickel  
**8885-OB** oil rubbed bronze  
 1 1/8" X 2 3/4"  
 Overall width at lip: 1 9/16"  
 Center to lip: 1"  
 Solid brass  
*"T" strike plate*  
 For doors up to 1 1/2" thick  
 For left-hand and right-hand doors



**8887-PB** polished brass  
**8887-PL** lacquered brass  
**8887-OB** oil rubbed bronze  
**8887-PN** polished nickel  
**8887-BN** brushed nickel  
 15/16" X 3 13/16"  
 Overall wide at lip: 1 7/16"  
 Center to lip: 15/16"  
 Solid brass  
*Door strike plate*  
 For doors up to 1 7/8" thick  
 For left-hand and right-hand doors

Strike plates for doors



**8881-PB** polished brass  
**8881-PL** lacquered pol. brass  
**8881-PN** polished nickel  
**8881-BN** brushed nickel  
**8881-OB** oil rubbed bronze  
 15/16" X 4 3/8"  
 Overall width at lip: 1 1/2"  
 Center to lip: 1 1/16"  
 Solid brass  
*Door strike plate*  
 For doors up to 1 3/4" thick  
 For left-hand and right-hand doors

Website: [www.timelyhardware.com](http://www.timelyhardware.com)

*Large, heavy duty strike plate*  
 Designed to fit all exterior mortise locks



**8880-PB** polished brass  
**8880-PL** lacquered pol. brass  
**8880-PN** polished nickel  
**8880-BN** brushed nickel  
**8880-OB** oil rubbed bronze  
 1 3/16" X 6"  
 Overall width at lip: 1 7/8"  
 Center to lip: 1 1/4"  
 Solid brass  
*Exterior door strike plate*  
 For doors up to 2" thick  
 For left-hand and right-hand doors



**8879-PB** polished brass  
**8879-PL** lacquered pol. brass  
**8879-PN** polished nickel  
**8879-BN** brushed nickel  
**8879-OB** oil rubbed bronze  
 1 1/4" X 4 7/8"  
 Overall width at lip: 2 1/4"  
 Center to lip: 1 5/8"  
 Solid brass  
  
*Mid-size extended lip strike plate*  
 for doors up to 2 1/2" thick

*Extended lip strike plates*  
 For both left-hand and right-hand doors



**8878-PB** polished brass  
**8878-PL** lacquered pol. brass  
**8878-OB** oil rubbed bronze  
**8878-BN** brushed nickel  
**8878-PN** polished nickel  
 Frame: 1 1/4" X 4 7/8"  
 Overall width at lip: 2 7/8"  
 Center to lip: 2 1/4"  
 Solid brass

*Large extended lip strike plate*  
 for doors up to 3 1/2" thick



**8836-PB** polished brass  
**8836-PL** lacquered polished brass  
**8836-PN** polished nickel  
**8836-BN** brushed nickel  
**8836-OB** oil rubbed bronze  
 1 1/8" X 1 5/8"  
 Stamped brass  
*Door keyhole plate - oval*



**8835-PB** polished brass  
**8835-PL** lacquered polished brass  
**8835-PN** polished nickel  
**8835-BN** brushed nickel  
**8835-OB** oil rubbed bronze  
 1 1/4" X 1 3/4"  
 Stamped brass  
*Door keyhole plate - rectangular*



**8726-PB** polished brass  
**8726-PL** lacquered polished brass  
**8726-PN** polished nickel  
**8726-BN** brushed nickel  
**8726-OB** oil rubbed bronze  
 1 1/16" X 1 3/4"  
 Forged brass  
*Door keyhole plate*



*Skeleton key for door locks will operate most bit-key locks on the market*

**8730-PB** polished brass  
**8730-PN** polished nickel  
 3 1/8" total length  
 Bit is 3/8" X 3/8"  
 High tensile forged brass  
*Skeleton key*

*Threaded for 8-32 TPI*



**6685-SS**  
 Total length: 2 3/8"  
 Length of threaded area: 1 3/4"  
 8-32 TPI  
 Stainless steel, with slotted drive  
*Replacement screws for vintage mortise locks*  
 Sold in pairs

*Replacement screws for entrance door mortise locks can be cut to length as needed. We offer the untapped screws as different vintage lock manufacturers used different TPIs. Order them and tap your own.*

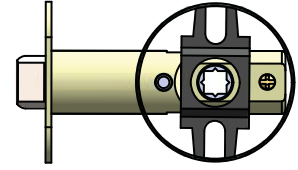
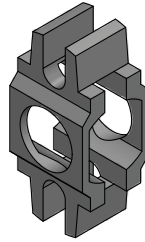

*Shown on door latch*

**8884** alignment block for tubular door latches  
 2 1/8" dia.  
 Plastic, black  
 This piece - part of our standard door latch sets - is used to stabilize the latch in the door. With a diameter of 2-1/8" it fits snugly in the standard pre-drilled holes on the faces of doors. And in its turn, the latch sits snugly inside it.

### ACCESSORIES FOR DOOR LATCH SETS

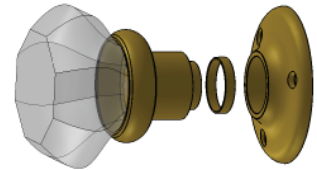

**8660-PB** polished brass  
**8660-OB** oil rubbed bronze  
**8660-PN** polished nickel  
**8660-BN** brushed nickel  
 Outer diameter: 3/4" (.714")  
 Inner diameter: 5/8" (.618")  
 Thickness: 1/16" (.05"), height: 5/32" (.15")  
 Brass

*Adapter ring for doorknob or door rose - increases the doorknob's base diameter by 1/16" or decreases the rose's hub diameter by 1/16". For optional use with roses #8740, #8741 and #8743.*

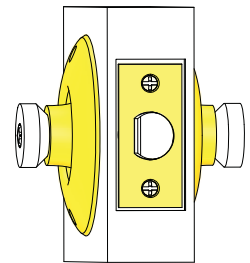

**8779**  
 Steel, zinc plated  
*Alignment tool for door trim*

*Consisting of 2 cones on a spindle, this simple but effective tool is used for aligning and marking holes of door plates and roses for accurate installation*

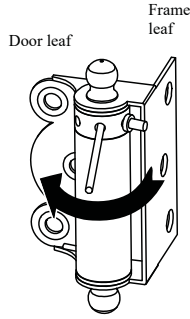

Install hinge on frame and door  
 Insert a small screwdriver or a rigid long pin in a hole and turn round piece to tighten spring  
 Insert stop-pin in a hole to fix the desired tension

*Half-surface*



**8507-PB** polished brass  
**8507-AB** antique brass  
**8507-PL** laquered brass  
**8507-PN** polished nickel  
**8507-BN** brushed nickel  
**8507-OB** oil rubbed bronze  
 2 3/4" high (ball tips add 1/2" each end)  
 Brass with steel spring  
*Half-surface hinge with a concealed spring  
 For screens and other self-closing doors*

Large

*Time saver. Mortise leaf fastened to frame, other leaf to door's surface.  
 Coil spring with adjustable tension, can be regulated after installation.*

Screen door hinges

*Full-surface*



**8506-PB** polished brass  
**8506-AB** antique brass  
**8506-PL** laquered brass  
**8506-PN** polished nickel  
**8506-BN** brushed nickel  
**8506-OB** oil rubbed bronze  
 2 1/4" wide  
 2 3/4" high (without ball tips)  
 Brass  
*Full-surface hinge with a concealed spring  
 For screens and other self-closing doors*

Large

Powerful springs - avoid pinching

Screen door pull



**1132-PB** polished brass  
**1132-AB** antique brass  
**1132-PL** lacquered polished brass  
**1132-PN** polished nickel  
**1132-BN** brushed nickel  
**1132-OB** oil rubbed bronze  
 4 3/4" long  
 4 1/8" center to center  
 Solid brass  
*Screen door pull*

*Full-surface*



**8509-PB** polished brass  
**8509-AB** antique brass  
**8509-PN** polished nickel  
**8509-BN** brushed nickel  
**8509-OB** oil rubbed bronze  
 1 3/4" wide  
 1 3/4" leaf height  
 Steel  
*Screen door hinge with spring  
 Sold in pairs*

Small

*Sold in pairs*

Powerful springs - avoid pinching

Rim latch



- 8501-PB** polished brass
- 8501-PL** lacquered brass
- 8501-AB** antique brass
- 8501-BN** brushed nickel
- 8501-PN** polished nickel
- 8501-OB** oil rubbed bronze

Case: 2" X 2 1/4" X 5/8"  
 Lever: 1 3/4" long, 2" projection  
 Knob: 1 3/4" dia., 2" projection  
 Door plate: 1 3/8" X 3"  
 Angle strike: 1 3/4" long, 7/16" wide, 13/16" high  
 Solid brass with *steel spindle*

**With lever inside and knob outside**

Stop button can lock latch in either position  
 For door thickness from 7/8" to 1 3/4"  
 For right- and left-handed doors  
 Comes with reverse bevel and an angle strike - bevel is reversible  
 Includes hex key for set-screws



*Latch shown with box strike*



*Optional:  
box strike  
for screen  
latch*

- 8502-PB** polished brass
- 8502-PL** lacquered brass
- 8502-AB** antique brass
- 8502-BN** brushed nickel
- 8502-PN** polished nickel
- 8502-OB** oil rubbed bronze

2 1/4" long, 5/8" wide, 5/8" high  
 Solid brass  
*Box strike for the screen door latch shown above .  
 sold by itself.  
 Requires changing the latch from reverse bevel  
 to STANDARD bevel .*

Mortise latch



- 8503-PB** polished brass
- 8503-PL** lacquered brass
- 8503-PN** polished nickel
- 8503-OB** oil rubbed bronze

1-3/4" backset  
 Latch tube 2-5/8" long, 5/8" dia.  
 Lever: 2" long, 2" projection  
 Knob: 1 3/4" dia., 2" projection  
 Rosettes: 1 7/8" dia.  
 Strike: 1-3/4" wide  
 Brass and some steel parts

**With lever inside and knob outside**

Latch can be locked from inside  
 For door thickness from 7/8" to 1 5/8"  
 For right- and left-handed doors

Mortise Bolt

For doors, windows, sashes etc.  
 Right or left



Without lacquer

- 8505-PB** polished brass
- 1-3/4" backset  
 Latch tube 2-1/2" long, 9/16" dia.  
 Oval knob: 1" long, 7/8" projection  
 Oval plate: 1" X 1 3/4"  
 Strike: 1 3/4" X 7/8"  
 Finish: polished brass (not lacquered)  
 Steel and zinc alloy components

Screen door latches



4" long

- 8720-PB** polished brass
  - 8720-AB** antique brass
  - 8720-OB** oil rubbed bronze
  - 8720-PN** polished nickel
  - 8720-BN** brushed nickel
- 4" long  
 Half rod: 1/2" dia.  
 Guide brackets: 1 3/8" wide  
 3/4" knob dia.  
 Solid brass  
*Surface bolt with 2 strikes*

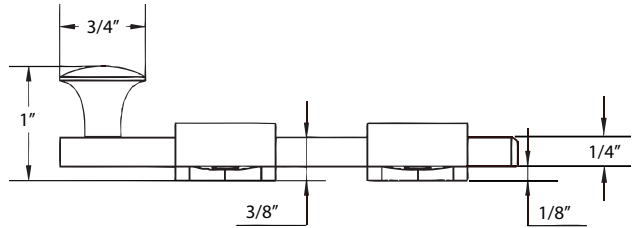

Heavy duty surface bolts for windows,  
 French windows and doors

In 3 lengths and 5 finishes

1/2" dia. half rod - 1 3/8" wide brackets (stays) - 3/4" dia. knob

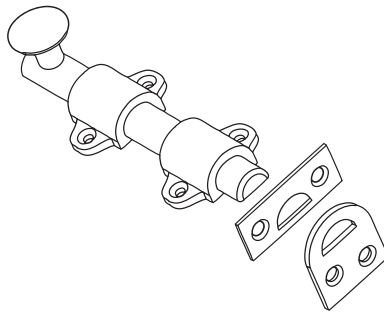

6" long

- 8721-PB** polished brass
  - 8721-AB** antique brass
  - 8721-PN** polished nickel
  - 8721-BN** brushed nickel
  - 8721-OB** oil rubbed bronze
- 6" long  
 Half rod: 1/2" dia.  
 Guide brackets: 1 3/8" wide  
 3/4" knob dia.  
 Solid brass  
*Surface bolt with 2 strikes*



9" long

- 8722-PB** polished brass
  - 8722-AB** antique brass
  - 8722-PN** polished nickel
  - 8722-BN** brushed nickel
  - 8722-OB** oil rubbed bronze
- 9" long  
 Half rod: 1/2" dia.  
 Guide brackets: 1 3/8" wide  
 3/4" knob dia.  
 Solid brass  
*Surface bolt with 2 strikes*





4" long

- 8823-PB** polished brass
  - 8823-AB** antique brass
  - 8823-PN** polished nickel
  - 8823-BN** brushed nickel
  - 8823-OB** oil rubbed bronze
- 4" long  
 Half rod: 3/8" dia.  
 Guide brackets: 1 1/4" wide  
 Solid brass  
*Surface bolt with 3 strikes*



2" long

- 8822-PB** polished brass
  - 8822-AB** antique brass
  - 8822-PN** polished nickel
  - 8822-BN** brushed nickel
  - 8822-OB** oil rubbed bronze
- 2" long  
 Half rod: 3/8" dia.  
 Guide brackets: 1 1/4" wide  
 Solid brass  
*Surface bolt with 2 strikes*

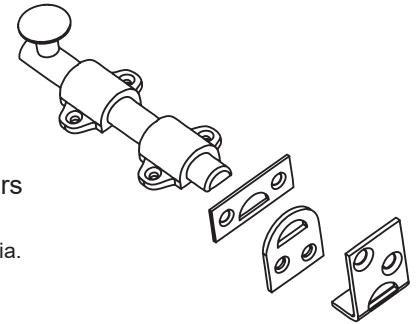

Surface bolts for windows, French windows and doors  
 In 4 lengths and 5 finishes

half rod: 3/8" dia. - Brackets (stays): 1 1/4" wide - knob: 1/2" dia.

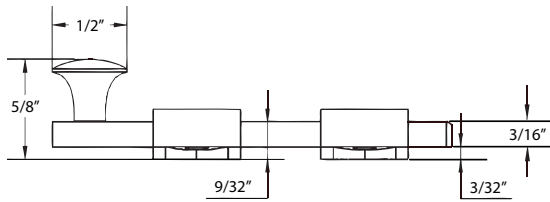

6" long

- 8824-PB** polished brass
  - 8824-AB** antique brass
  - 8824-PN** polished nickel
  - 8824-BN** brushed nickel
  - 8824-OB** oil rubbed bronze
- 6" long  
 Half rod: 3/8" dia.  
 Guide brackets: 1 1/4" wide  
 Solid brass  
*Surface bolt with 3 strikes*

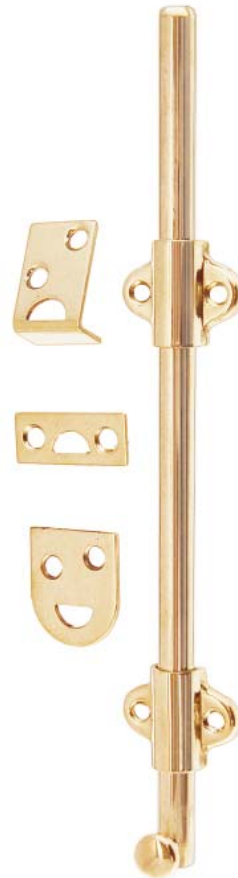

8" long

- 8825-PB** polished brass
  - 8825-AB** antique brass
  - 8825-PN** polished nickel
  - 8825-BN** brushed nickel
  - 8825-OB** oil rubbed bronze
- 8" long  
 Half rod: 3/8" dia.  
 Guide brackets: 1 1/4" wide  
 Solid brass  
*Surface bolt with 3 strikes*

3" X 3"

Door and window hinge



**8780-PL** lacquered pol. brass  
**8780-PN** polished nickel  
**8780-BN** brushed nickel  
**8780-OB** oil rubbed bronze  
 3" X 3"  
 98 gauge  
 Ball tips: 1/2" dia.  
 Steel  
 #9 X 1" screws  
*Sold in pairs*  
*Architectural grade*  
*For doors or large windows*



**Square steel door hinges with ball tips**  
 Removable stainless steel pins  
 (Upper ball tip & pin are one piece of steel)  
 5 knuckles, swaged  
 Architectural grade  
 Sold in pairs

Door hinges

4" X 4"

3 1/2" X 3 1/2"



**8781-PL** lacquered pol. brass  
**8781-PN** polished nickel  
**8781-BN** brushed nickel  
**8781-OB** oil rubbed bronze  
 3 1/2" X 3 1/2"  
 135 gauge  
 Ball tips: 9/16" dia.  
 Steel  
 #10 X 1" screws  
*Sold in pairs*  
*Architectural grade*



**8782-PL** lacquered pol. brass  
**8782-PN** polished nickel  
**8782-BN** brushed nickel  
**8782-OB** oil rubbed bronze  
 4" X 4"  
 135 gauge  
 Ball tips: 9/16" dia.  
 Steel  
 #12 X 1-1/4" screws  
*Sold in pairs*  
*Architectural grade*





Small

- 1409-PB** polished brass
- 1409-BN** brushed nickel
- 1409-PN** polished nickel
- 1409-OB** oil rubbed bronze
- 1409-PL** lacquered brass
- 1409-AB** antique brass
- 3 1/2" center to center
- 4" overall length , 1 1/16" wide
- Solid brass

Bar sash lifts



Medium

- 1410-PB** polished brass
- 1410-BN** brushed nickel
- 1410-PN** polished nickel
- 1410-OB** oil rubbed bronze
- 1410-PL** lacquered brass
- 1410-AB** antique brass
- 4" center to center
- 4 3/4" overall length , 1 1/4" wide
- Solid brass

*Large size enabling a better grip*



Large

- 1412-PB** polished brass
- 1412-PL** lacquered brass
- 1412-AB** antique brass
- 1412-BN** brushed nickel
- 1412-PN** polished nickel
- 1412-OB** oil rubbed bronze
- 4 3/8" center to center
- 5" overall length , 1 3/16" wide
- Solid brass

*For sashes, windows, tambour drops, etc.*

Hook sash lift



- 1573-PB** polished brass
- 1573-PL** lacquered brass
- 1573-AB** antique brass
- 1573-BN** brushed nickel
- 1573-PN** polished nickel
- 1573-OB** oil rubbed bronze
- Frame: 1 3/4" X 7/8"
- Wrought brass
- With beveled edges*

SASH WINDOW LIFTS

*Recessed sash lift*



- 8812-PB** polished brass
- 8812-PL** lacquered brass
- 8812-PN** polished nickel
- 8812-BN** brushed nickel
- 8812-OB** oil rubbed bronze
- 8812-AB** antique brass
- 3 1/8" X 1 5/8"
- Recessed area: 2 1/2" X 1"
- Wrought brass
- With beveled edges*

Regular size



**8810-PB** polished brass  
**8810-PL** lacquered polished brass  
**8810-AB** antique brass  
**8810-PN** polished nickel  
**8810-BN** brushed nickel  
**8810-OB** oil rubbed bronze  
 Latch base: 2 1/2" X 7/8"  
 Catch base: 2 1/2" X 9/16"  
 Solid brass  
*Sash window lock*  
*Regular size for standard windows*  
*With rounded bases*

Larger size



**8710-PB** polished brass  
**8710-PL** lacquered polished brass  
**8710-AB** antique brass  
**8710-PN** polished nickel  
**8710-BN** brushed nickel  
**8710-OB** oil rubbed bronze  
 Latch base: 2 7/8" X 1"  
 Strike base: 2 7/8" X 5/8"  
 Solid brass  
*Sash window lock*  
*Larger size for larger windows*  
*With rounded bases*

#8810 sash lock  
 shown with #8813 strike



Hardware for sash  
 (double hung) windows



**8813-PB** polished brass  
**8813-PL** lacquered polished brass  
**8813-AB** antique brass  
**8813-PN** polished nickel  
**8813-BN** brushed nickel  
**8813-OB** oil rubbed bronze  
 2 1/2" X 1"  
 Solid brass  
*Sash lock strike*

*An alternative way to secure a double-hung window, this simple flat strike can be used with sash locks 8810 and 8708. Ordered by itself*

Regular size



**8708-PB** polished brass  
**8708-PL** lacquered polished brass  
**8708-AB** antique brass  
**8708-PN** polished nickel  
**8708-BN** brushed nickel  
**8708-OB** oil rubbed bronze  
 Latch base: 2 1/2" X 1"  
 Strike base: 2 1/2" X 7/16"  
 Solid brass  
*Sash window lock*  
*Regular size for standard windows*  
*With square bases*

Narrow strike



**8809-PB** polished brass  
**8809-PL** lacquered polished brass  
**8809-OB** oil rubbed bronze  
**8809-PN** polished nickel  
**8809-BN** brushed nickel  
 7/16" wide , 2 1/2" long  
 Solid brass  
*A narrow replacement strike for #8810 sash locks used where the window seal will not accept a regular strike*



*Comes with a 1/16" thick base plate to adjust the height of the strike as needed*



**8709-PB** polished brass  
**8709-PL** lacquered brass  
**8709-AB** antique brass  
**8709-PN** polished nickel  
**8709-BN** brushed nickel  
**8709-OB** oil rubbed bronze  
 Latch base: 1 7/8" X 1 1/8"  
 Strike base: 1 7/8" X 3/4"  
 Solid bronze  
*Spring loaded sash lock and lift, made of bronze for added strength, in 6 finishes*



*Spring loaded bolt can be kept retracted*



*comes with 3 strikes so sash window can be secured at 3 opening levels*



**8716-PB** polished brass  
**8716-AB** antique brass  
**8716-PL** lacquered brass  
**8716-PN** polished nickel  
**8716-BN** brushed nickel  
**8716-OB** oil rubbed bronze  
 Case: 1 3/16" X 1 1/4"  
 Bolt: 2 1/4" long , 5/16" dia.  
 Solid brass  
*Comes with 3 strikes*

Hardware for sash (double hung) windows

*For mounting wood molding strips on the frame to retain and align inner sash windows*

*Will lock sash window at any position and prevent window from rattling*



**8808-PB** polished brass  
**8808-AB** antique brass  
**8808-PL** lacquered brass  
**8808-PN** polished nickel  
**8808-BN** brushed nickel  
**8808-OB** oil rubbed bronze  
 Stop plate: 1 5/8" long  
 Lever: 2 1/4" long  
 Solid brass  
*Side sash lock*



**8707-PB** polished brass  
**8707-AB** antique brass  
**8707-PL** lacquered brass  
**8707-PN** polished nickel  
**8707-BN** brushed nickel  
**8707-OB** oil rubbed bronze  
 Cup washers fit in an 11/16" bore  
 Permit 1/8" sideways adjustment  
 Steel  
*Stop bead adjusters  
 Sold in pairs*

R.H.



**8713-PB** polished brass  
**8713-PN** polished nickel  
**8713-BN** brushed nickel  
**8713-OB** oil rubbed bronze  
 Latch base: 3/4" X 2 1/2"  
 Solid brass  
 Right Hand  
 With lever handle

L.H.



**8714-PB** polished brass  
**8714-PN** polished nickel  
**8714-BN** brushed nickel  
**8714-OB** oil rubbed bronze  
 Latch base: 3/4" X 2 1/2"  
 Solid brass  
 Left Hand  
 With lever handle

**Casement window latches**

Come with 2 strikes: Mortise and Rim  
 For left-Hand or right-hand windows



**8712-PB** polished brass  
**8712-PL** lacquered brass  
**8712-PN** polished nickel  
**8712-BN** brushed nickel  
**8712-OB** oil rubbed bronze  
 Latch base: 1 1/16" X 1 9/16"  
 Solid brass  
 Casement window latch with ring handle .reversible for right or left.  
 Comes with 2 strikes: Mortise, Rim

Mortise Rim Surface



Smaller

**8811-PB** polished brass  
**8811-PL** lacquered brass  
**8811-AB** antique brass  
**8811-PN** polished nickel  
**8811-BN** brushed nickel  
**8811-OB** oil rubbed bronze  
 Latch base: 7/8" X 1 9/16"  
 Solid brass  
 Standard size

Casement window latch in 2 sizes  
 Comes with 3 strikes: Surface, Mortise, Rim  
 Reversible for right or left hand window

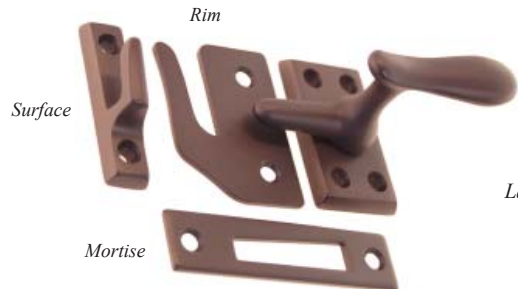

Larger

**8711-PB** polished brass  
**8711-PL** lacquered brass  
**8711-AB** antique brass  
**8711-PN** polished nickel  
**8711-BN** brushed nickel  
**8711-OB** oil rubbed bronze  
 Latch base: 1 1/8" X 2"  
 Solid brass  
 Larger version for larger windows

10" long arm



- 8790-PB** polished brass
  - 8790-AB** antique brass
  - 8790-PL** lacquered brass
  - 8790-PN** polished nickel
  - 8790-BN** brushed nickel
  - 8790-OB** oil rubbed bronze
- Rod: 10" long, 3/8" dia.  
 Plates: 2 3/8" X 1"  
 Solid brass

### Casement window hardware

Authentic replicas of old style window adjusters with knurled knob and beveled base plates  
 A short plastic sleeve encased in the assembly prevents marks on the rod  
 Reversible for right or left-hand windows opening out

12" long arm



- 8791-PB** polished brass
  - 8791-AB** antique brass
  - 8791-PL** lacquered brass
  - 8791-PN** polished nickel
  - 8791-BN** brushed nickel
  - 8791-OB** oil rubbed bronze
- Rod: 12" long, 3/8" dia.  
 Plates: 2 3/8" X 1"  
 Solid brass

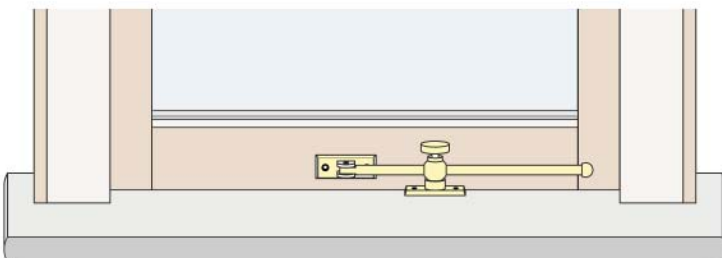



Well-made shutter bolts designed to minimize rattle  
 Steel - the lower price alternative  
 Stainless steel - premium quality

**9725-BK**  
 Bolt 6 3/4" long  
 Bolt base: 7 1/4" X 2"  
 Strike base: 3 1/2" X 2"  
 Steel  
 Flat black

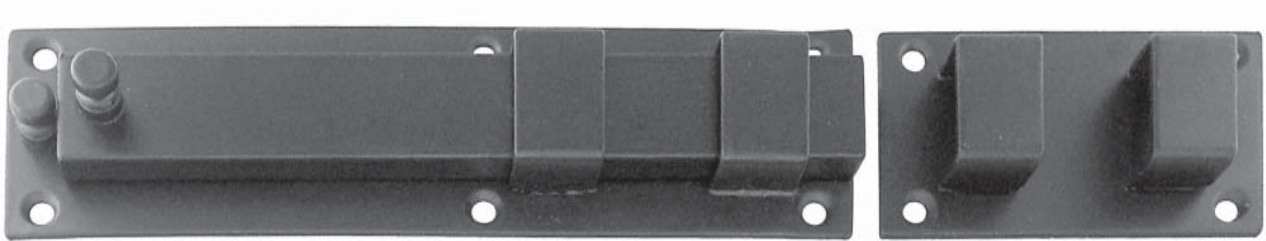

*Premium quality stainless steel shutter bolt*

**9720-BK**  
 Bolt 6 3/4" long  
 Bolt base: 7 1/4" X 2"  
 Strike base: 3 1/2" X 2"  
 Stainless Steel  
 Flat black

**S-Scroll Shutter Fasteners**  
 (Shutter dogs)  
 Can be used in wood or brick  
 Reversible for right or left

*Larger*



**8802-BK**  
 8 1/4" high  
 Cast iron, flat black  
 With 4 3/8" long lag screw

*Smaller*



**8801-BK**  
 5 3/4" high  
 Cast iron, flat black  
 With 4 3/8" long lag screw



Ornate

**8815-PB** polished brass  
**8815-PL** lacquered brass  
**8815-PN** polished nickel  
**8815-OB** oil rubbed bronze  
 Bases: 1" X 1 7/8"  
 Bar: 2 1/2" long  
 Solid brass

Shutter bars, reversible for right and left hands



Plain

**8816-PB** polished brass  
**8816-PL** lacquered brass  
**8816-PN** polished nickel  
**8816-OB** oil rubbed bronze  
 Bases: 7/8" X 1 3/4"  
 Bar: 2 1/4" long  
 Solid brass

White porcelain knobs with 2 brass plated screws  
 Screw goes through the center of the knob  
 Install with either the screw or the bolt  
 For shutters, pictures, drawers etc.



**5673**  
 1" dia.  
 7/8" projection  
 White porcelain  
 1 woodscrew + 1 machine screw



**5674**  
 1 1/4" dia.  
 1" projection  
 White porcelain  
 1 woodscrew + 1 machine screw



Good Hardware  
 at Good Prices

For sashes hung flush with the casing or set out of the casing



**1529-BK**  
 3/4" wide (1-1/4" at widest)  
 Steel bar, painted black  
 Heavy duty hangers for heavier storm windows and screens  
 Sold in pairs

Storm Sash / Window Screen Hangers

For sashes set in beyond the face of the casing (offset)



**1530-ZP**  
 2" wide  
 Stamped steel, zinc plated  
 Sturdy hangers for storm windows and screens  
 Sold in pairs



**1615-BK**  
 1 7/8" long  
 Cast iron, painted black  
 Japanned turn buttons for storm screens, sash windows, cupboards etc.  
 Sold in pairs

*Screws in the brackets enable changing length of chain*



**8803-PL** lacquered pol. brass  
**8803-BN** brushed nickel  
**8803-OB** oil rubbed bronze  
**8803-PN** polished nickel  
 Chain length up to 15"  
 Bases: 1" X 1 1/2"  
 Solid brass bases, steel chain  
 Chain length is adjustable



**8804-PB** polished brass  
**8804-BN** brushed nickel  
**8804-OB** oil rubbed bronze  
**8804-PN** polished nickel  
 12" long chain  
 Bases: 1" X 1 1/2"  
 Steel bases, steel chain

**8705-PB** polished brass  
**8705-PL** lacquered brass  
**8705-PN** polished nickel  
**8705-BN** brushed nickel  
**8705-OB** oil rubbed bronze

Base of latch: 1 7/8" X 1 1/8"  
 Base of box strike: 1 7/8" X 7/16"  
 Base of universal strike: 1 1/2" X 11/16"  
 Forged brass  
 Small transom latch with regular bevel  
 Comes with 2 strikes



*Small*



*Can be used with latch #8806, shown below, instead of the flat strike that comes with it*

**8706-PB** polished brass  
**8706-PL** lacquered brass  
**8706-PN** polished nickel  
**8706-BN** brushed nickel  
**8706-OB** oil rubbed bronze

Base of strike: 2 1/8" X 9/16"  
 Solid brass  
 Box strike for large transom latch  
 Sold by itself

Transom window hardware



**8805-PB** polished brass  
 3 3/4" long  
 7/8" dia. pole hole  
 Solid brass  
 With 2 screws  
 Pull down hook for transom latches  
 (pole not included)



*When in use*



**8807-PB** polished brass  
 1 3/16" X 2 3/8"  
 Solid brass  
 Handy transom pole hanger



*When not in use*

Latch #8806 shown with strike #8706

*Large*



**8806-PB** polished brass  
**8806-PL** lacquered polished brass  
**8806-PN** polished nickel  
**8806-BN** brushed nickel  
**8806-OB** oil rubbed bronze

Latch base: 2 1/8" X 1 1/2"  
 Solid brass  
 Large transom latch with regular bevel  
 Comes with a universal (flat) strike

*Can be used with #8706 box strike (shown above), sold separately*



Door and window hinge

3" X 3"



**8780-PL** lacquered pol. brass  
**8780-PN** polished nickel  
**8780-BN** brushed nickel  
**8780-OB** oil rubbed bronze  
 3" X 3"  
 98 gauge  
 Ball tips: 1/2" dia.  
 Steel  
 #9 X 1" screws  
*Sold in pairs*  
*Architectural grade*  
*For doors or large windows*

3 1/2" X 3 1/2"



**8781-PL** lacquered pol. brass  
**8781-PN** polished nickel  
**8781-BN** brushed nickel  
**8781-OB** oil rubbed bronze  
 3 1/2" X 3 1/2"  
 135 gauge  
 Ball tips: 9/16" dia.  
 Steel  
 #10 X 1" screws  
*Sold in pairs*  
*Architectural grade*

Door hinges

Square steel door hinges with ball tips

Removable stainless steel pins  
 (Upper ball tip & pin are one piece of steel)  
 5 knuckles, swaged  
 Architectural grade  
 Sold in pairs



4" X 4"



**8782-PL** lacquered pol. brass  
**8782-PN** polished nickel  
**8782-BN** brushed nickel  
**8782-OB** oil rubbed bronze  
 4" X 4"  
 135 gauge  
 Ball tips: 9/16" dia.  
 Steel  
 #12 X 1-1/4" screws  
*Sold in pairs*  
*Architectural grade*

2 1/2"



*Smaller Parliament hinge  
 for cabinets with clearance*

**8817-PB** polished brass  
**8817-PN** polished nickel  
**8817-BN** brushed nickel  
**8817-OB** oil rubbed bronze  
 2 1/2" X 1 3/4"  
 1/16" gauge  
 Solid brass

3"



**8818-PB** polished brass  
**8818-PN** polished nickel  
**8818-BN** brushed nickel  
**8818-OB** oil rubbed bronze  
 3" X 2 1/4"  
 Solid brass

3 1/2"



**8819-PB** polished brass  
**8819-PN** polished nickel  
**8819-BN** brushed nickel  
**8819-OB** oil rubbed bronze  
 3 1/2" X 2 1/2"  
 Solid brass

Solid brass Parliament hinges come in 5 sizes  
 For shutters, windows, doors with clearance from wall

With heavy-gauge (3/32" thick) swaged leaves  
 Stainless steel removable pins with ball tips - reversible

4"



**8820-PB** polished brass  
**8820-PN** polished nickel  
**8820-BN** brushed nickel  
**8820-OB** oil rubbed bronze  
 4" X 2 1/2"  
 Solid brass

4 1/2"



**8821-PB** polished brass  
**8821-PN** polished nickel  
**8821-BN** brushed nickel  
**8821-OB** oil rub'd bronze  
 4 1/2" X 2 1/2"  
 Solid brass



- 1811-PB** polished brass
  - 1811-PL** lacquered brass
  - 1811-AB** antique brass
  - 1811-PN** polished nickel
  - 1811-BN** brushed nickel
  - 1811-OB** oil rubbed bronze
  - 1811-CPR** polished copper
  - 1811-PC** polished chrome
  - 1811-BC** brushed chrome
- 1 1/2" X 1 1/2"



- 1812-PB** polished brass
  - 1812-PL** lacquered brass
  - 1812-AB** antique brass
  - 1812-PN** polished nickel
  - 1812-BN** brushed nickel
  - 1812-OB** oil rubbed bronze
  - 1812-CPR** polished copper
  - 1812-PC** polished chrome
  - 1812-BC** brushed chrome
- 1 1/2" X 2"

**Premium solid brass extruded cabinet hinges**

High precision machined, with ball tips

Heavy gauge (3/32" leaf thickness)

4 sizes - 9 finishes



- 1813-PB** polished brass
  - 1813-PL** lacquered brass
  - 1813-AB** antique brass
  - 1813-PN** polished nickel
  - 1813-BN** brushed nickel
  - 1813-OB** oil rubbed bronze
  - 1813-CPR** polished copper
  - 1813-PC** polished chrome
  - 1813-BC** brushed chrome
- 1 3/4" X 2 1/2"



- 1814-PB** polished brass
  - 1814-PL** lacquered brass
  - 1814-AB** antique brass
  - 1814-PN** polished nickel
  - 1814-BN** brushed nickel
  - 1814-OB** oil rubbed bronze
  - 1814-CPR** polished copper
  - 1814-PC** polished chrome
  - 1814-BC** brushed chrome
- 2" X 2 1/2"

*Small*



- 1821-PB** polished brass
  - 1821-PN** polished nickel
  - 1821-BN** brushed nickel
  - 1821-OB** oil rubbed bronze
  - 1821-AB** antique brass
  - 1821-AC** antique copper
- 1 3/8" X 2"
- Steel  
*Swaged, with removable pin*  
*Sold in pairs*

*Medium*



- 1822-PB** polished brass
  - 1822-PN** polished nickel
  - 1822-BN** brushed nickel
  - 1822-OB** oil rubbed bronze
  - 1822-AB** antique brass
  - 1822-AC** antique copper
- 1 5/8" X 1 15/16"
- Steel  
*Swaged, with removable pin*  
*Sold in pairs*

**Steel butt hinges with ball tips & removable pins**

3 sizes in 6 finishes

Faithful replicas of old style hinges for cabinets

*Large*

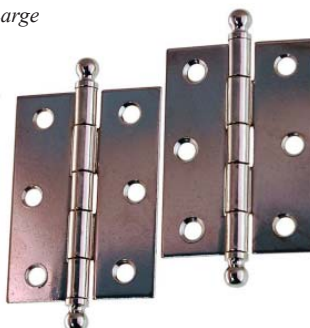

- 1823-PB** polished brass
  - 1823-PN** polished nickel
  - 1823-BN** brushed nickel
  - 1823-OB** oil rubbed bronze
  - 1823-AB** antique brass
  - 1823-AC** antique copper
- 1 3/4" X 2 7/16"
- Steel  
*Swaged, with removable pin*  
*Sold in pairs*

*Flush mount*



- 1580-PB** polished brass
  - 1580-BN** brushed nickel
  - 1580-PN** polished nickel
  - 1580-OB** oil rubbed bronze
- 2 1/4" X 1 1/2"
- Solid brass  
*Flush mounting*

Art Deco style

*Offset mount*



- 1581-PB** polished brass
  - 1581-BN** brushed nickel
  - 1581-PN** polished nickel
  - 1581-OB** oil rubbed bronze
- 2 1/4" X 1 1/2"
- 3/8" offset  
Solid brass



**1502-PB** polished brass  
**1502-PN** polished nickel  
 3/8" offset  
 3" long  
 1 5/8" wide  
 Solid brass, *hand polished*

Ice Box or refrigerator Hinges



**1500-PB** polished brass  
**1500-PL** lacquered brass  
**1500-PN** polished nickel  
**1500-AB** antique brass  
 3/8" offset  
 3 1/2" long  
 1 7/8" wide  
 Solid brass, *hand polished*



**1575-PB** polished brass  
**1575-PN** polished nickel  
 11" long, 5" at widest  
 Solid brass  
 Cast, highly polished  
*Heavy duty large hinge*

For doors, gates, refrigerators etc.



**1550-PB**  
 1 1/2" X 2"  
 Steel - brass plated  
*Simple small butt hinge*  
*Screws not included*



**1552-ST**  
 1 5/8" X 1 3/16" (when open)  
 Short flap 11/16" long  
 Long flap 15/16" long  
 Steel, polished steel finish  
*A simple old-style butt hinge*  
*with 2 leaves of different lengths*

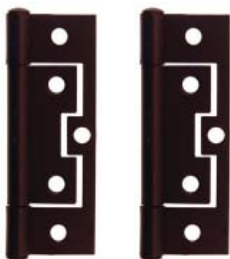

**9558**  
 3" high  
 Large leaf 1 1/8" wide  
 Small leaf 13/16" wide  
 Steel  
 Flat black finish  
*Non-mortise hinges*  
*Sold in pairs*

Small



**1553-AC**  
 2" high (without tips)  
 Large leaf 7/8" wide  
 Small leaf 3/4" wide  
 Steel  
 Antique copper finish  
*Sold in pairs*

Non-mortise hinges with ball tips

Large



**1554-AC**  
 2 1/2" high (without tips)  
 Large leaf 1" wide  
 Small leaf 3/4" wide  
 Steel  
 Antique copper finish  
*Sold in pairs*

For Arts & Crafts and Mission cabinet doors

Small



**1556-AC**  
 2" high (without tips)  
 Large leaf 7/8" wide  
 Small leaf 3/4" wide  
 Steel  
 Antique copper finish  
*Sold in pairs*

Non-mortise hinges with steeple tips

Large



**1557-AC**  
 2 1/2" high (without tips)  
 Large leaf 1" wide  
 Small leaf 3/4" wide  
 Steel  
 Antique copper finish  
*Sold in pairs*

Removable  
pin



**1561-PB** polished brass  
**1561-AB** antique brass  
**1561-AC** antique copper  
**1561-PN** polished nickel  
**1561-OB** oil rubbed bronze  
 2 3/8" X 1 3/4"  
 Steel  
 Sold in pairs

Removable  
pin



**1563-PB** polished brass  
**1563-AC** antique copper  
**1563-PN** polished nickel  
**1563-OB** oil rubbed bronze  
 2 1/2" X 2"  
 Steel  
 Sold in pairs



**1567-PB** polished brass  
**1567-AC** antique copper  
**1567-PN** polished nickel  
**1567-OB** oil rubbed bronze  
 3 3/4" X 1 3/4"  
 Steel  
 Sold in pairs

Removable pin



Reversible surface or half-surface hinges are obtained by combining hinge #1566 with hinges #1561, #1563, #1567

Any two hinges will make a pair of mixed hinges



Mixed full-surface hinges are obtained by combining the leaves of hinges #1561, #1563 & #1567



**1560-PB** polished brass  
**1560-AB** antique brass  
**1560-AC** antique copper  
**1560-PN** polished nickel  
**1560-OB** oil rubbed bronze  
 2 3/8" X 2 1/4"  
 Steel  
 Sold in pairs



**1564-PB** polished brass  
**1564-AC** antique copper  
**1564-PN** polished nickel  
**1564-OB** oil rubbed bronze  
 2 7/8" X 1 11/16"  
 Steel  
 Sold in pairs

Ornamental embossed full-surface flush hinges  
 Dimensions given are for open hinge, as shown



**1562-PB** polished brass  
**1562-AC** antique copper  
**1562-PN** polished nickel  
**1562-OB** oil rubbed bronze  
 2" X 1 7/16"  
 Steel  
 Sold in pairs

With removable pin  
 Reversible



**1566-PB** polished brass  
**1566-AC** antique copper  
**1566-PN** polished nickel  
**1566-OB** oil rubbed bronze  
 1 1/2" X 1 1/2"  
 Steel  
 square butt hinge  
 Sold in pairs

Reversible flaps for use  
 as full-, half-, or non-surface hinge



**1626-PB** polished brass  
**1626-PN** polished nickel  
 3 1/8" X 1 1/2"  
 3/8" & 1/2" offset  
 Solid brass  
*Wraparound hinge*  
*Offset depends on which leaf is on frame and which on door*



**1627-PB** polished brass  
**1627-PN** polished nickel  
 2" X 2"  
 3/8" offset  
 Solid brass  
*Reversed pad*



**1628-PB** polished brass  
**1628-PN** polished nickel  
 2" X 1 1/2"  
 3/8" offset  
 Solid brass

Hinges for traditional kitchen cabinets

*Small*



**1601-PB** polished brass  
**1601-PN** polished nickel  
 1 5/8" X 1 1/2"  
 3/8" offset  
 Solid brass

Butterfly hinges



*Large*



**1602-PB** polished brass  
**1602-PN** polished nickel  
 1 3/4" X 2"  
 3/8" offset  
 Solid brass



**1600-PB** polished brass  
**1600-PN** polished nickel  
 2 1/4" X 1 5/8"  
 3/8" offset



**1594-PB** polished brass  
**1594-PN** polished nickel  
 2 1/2" X 1 1/2"  
 3/8" offset



**1593-PB** polished brass  
**1593-PN** polished nickel  
 1 3/4" X 1 1/4"  
 3/8" offset  
*Scalloped*

Hinges for Hoosier kitchen cabinets



**1599-PB** polished brass  
**1599-PN** polished nickel  
 2 3/8" X 1 1/2"  
 3/8" offset  
*Reversed pad*



**1591-PB** polished brass  
**1591-PN** polished nickel  
 2" X 1 3/4"  
 3/8" offset  
*Reversed pad*



**1592-PB** polished brass  
**1592-PN** polished nickel  
 1 7/8" X 1 3/4"  
 3/8" offset

**1535-PL** lacquered polished brass  
**1535-AB** antique brass  
 Overall height: 4 3/4", Width (open): 2 1/8"  
 Leaf height: 2 1/4", Height of tip: 1 1/4"  
 Leaf width: 3/4" (1" to inside of knuckle)  
 Leaf thickness: 1/8", knuckle dia: 7/16"  
 Solid brass  
 With steeple tips



Shown closed

L.H.



**1539-PB** polished brass  
**1539-PL** lacquered brass  
**1539-AB** antique brass

Height (w/o tips): 2 1/2"  
 Width (open): 1 3/4"  
 Leaf height: 1 3/16"  
 Leaf width (w/o knuckle): 3/4"  
 Leaf thickness: 3/32"  
 Height of tip: 1"  
 Solid brass  
 Left Hand

R.H.



**1540-PB** polished brass  
**1540-PL** lacquered brass  
**1540-AB** antique brass

Height (w/o tips): 2 1/2"  
 Width (open): 1 3/4"  
 Leaf height: 1 3/16"  
 Leaf width (w/o knuckle): 3/4"  
 Leaf thickness: 3/32"  
 Height of tip: 1"  
 Solid brass  
 Right Hand

High quality extruded and milled, heavy gauge solid brass swaged hinges with steeple tips  
 For armoires, wardrobes, clock case doors and cabinets with large doors



"Flag" hinges are handed. Be sure to order the correct hand. The upper (door) leaf can be lifted off the lower (frame) leaf.



**1536-PL** lacquered polished brass  
**1536-AB** antique brass  
 Overall height: 12", Width (open): 2 1/8"  
 Leaf height: 2 1/4", height of tip: 1 7/8"  
 Leaf width: 3/4" (1" to inside of knuckle)  
 Leaf thickness: 1/8", barrel diam.: 7/16"  
 Length of barrel between leaves: 3 7/8"  
 Solid brass  
 With steeple tips

L.H.



**1541-PB** polished brass  
**1541-PL** lacquered brass  
**1541-AB** antique brass

Height (w/o tips): 3 1/4"  
 Width (open): 1 3/4"  
 Leaf height: 1 9/16"  
 Leaf width (w/o knuckle): 3/4"  
 Leaf thickness: 3/32"  
 Height of tip: 1"  
 Solid brass  
 Left Hand

R.H.



**1542-PB** polished brass  
**1542-PL** lacquered brass  
**1542-AB** antique brass

Height (w/o tips): 3 1/4"  
 Width (open): 1 3/4"  
 Leaf height: 1 9/16"  
 Leaf width (w/o knuckle): 3/4"  
 Leaf thickness: 3/32"  
 Height of tip: 1"  
 Solid brass  
 Right Hand

Flush



**1582-PL**  
1 1/2" X 3 1/2"  
Solid brass - lacquered  
Flush mount

Machined brass Colonial style  
"H" cupboard hinges  
with beveled sides

Offset



**1583-PL**  
1 1/2" X 3 1/2"  
3/8" offset  
Solid brass - lacquered  
Offset mount



**1565-PB** brass plated  
**9565** flat black  
2" wide, 2 3/8" high  
Steel  
Flush mount  
Butterfly hinges  
Sold in pairs



**1570-PB**  
7" overall length (open)  
3/4" wide  
Steel, brass plated  
Slant Top Hinge

For desks, secretaries etc.



Butler tray hinge in 2 finishes

**1545-PL** lacquered brass  
**1545-AB** antique brass  
2 7/8" X 1 1/2"  
Sold in pairs

Locks at 90° and 180°

Smaller



**1422-PB** polished brass  
**1422-PN** polished nickel  
1 5/8" side length  
1 3/16" hinge length  
Steel  
Quadrant hinge

Quadrant hinges for boxes, humidors etc.

Larger



**1421-PB** polished brass  
**1421-PN** polished nickel  
1 7/8" side length  
1 5/8" hinge length  
Steel  
Quadrant hinge

Small



**1571-AC** antique copper  
**1571-BK** black  
**1571-PB** polished brass  
1 3/4" long  
For 3/4" wood thickness  
Steel  
Sold in pairs

Medium



**1572-AC** antique copper  
1 7/8" long  
For 1" wood thickness  
Steel  
Sold in pairs

Double acting hinges for screen / folding doors  
In 3 sizes and 2 finishes: antique copper & polished brass

Large



**1574-AC** antique copper  
**1574-PB** polished brass  
2" long  
For 1 1/8" wood thickness  
Steel  
Sold in pairs



**1160-PB** polished brass  
**1160-PN** polished nickel  
 3" center to center  
 3 1/2" wide  
 Stamped brass  
 With beveled edges



**1314-PB** polished brass  
**1314-BN** brushed nickel  
**1314-PN** polished nickel  
**1314-OB** oil rubbed bronze  
 3 1/4" center to center  
 3 3/4" wide  
 Heavy stamped brass

Stamped brass bin pulls



**1117-PB** polished brass  
**1117-BN** brushed nickel  
**1117-PN** polished nickel  
**1117-OB** oil rubbed bronze  
 3 3/4" wide, 1 3/4" high  
 Heavy-stamped brass

Large



**1163-PB** polished brass  
**1163-BN** brushed nickel  
**1163-PN** polished nickel  
**1163-OB** oil rubbed bronze  
 3" center to center  
 3 1/2" wide  
 Heavy-stamped brass

Traditional bin pulls in 2 sizes

Small



**1312-PB** polished brass  
**1312-BN** brushed nickel  
**1312-PN** polished nickel  
**1312-OB** oil rubbed bronze  
 2 1/2" center to center  
 3" wide  
 Heavy-stamped brass



**1115-PB** polished brass  
**1115-BN** brushed nickel  
**1115-PN** polished nickel  
**1115-OB** oil rubbed bronze  
 3 3/8" center to center  
 3 3/4" wide  
 Forged brass



**1310-PB** polished brass  
**1310-BN** brushed nickel  
**1310-PN** polished nickel  
**1310-OB** oil rubbed bronze  
 3 1/8" center to center  
 3 1/2" wide  
 Forged brass

Forged brass bin pulls

Large



**1429-PB** polished brass  
**1429-PL** lacquered brass  
**1429-PN** polished nickel  
**1429-BN** brushed nickel  
**1429-OB** oil rubbed bronze  
 4 1/2" overall length  
 4" center to center  
 Forged brass

Small



**1428-PB** polished brass  
**1428-PL** lacquered brass  
**1428-PN** polished nickel  
**1428-BN** brushed nickel  
**1428-OB** oil rubbed bronze  
 3 3/16" overall length  
 3" center to center  
 Forged brass

Good Hardware  
 at Good Prices





Small



**1135-PB** polished brass  
**1135-PN** polished nickel  
 3 1/4" wide, 3/4" high  
 2 3/4" center to center  
 Cast brass

Medium



**1136-PB** polished brass  
**1136 -PN** polished nickel  
 3 1/2" wide, 7/8" high  
 3" center to center  
 Cast brass

Ornate cast brass drawer / bin pulls in 3 sizes  
 and in 2 finishes: brass & nickel

Large



**1137-PB** polished brass  
**1137-PN** polished nickel  
 4" wide, 7/8" high  
 5/8" projection  
 3 1/2" center to center  
 Cast brass



**1134-PB** polished brass  
**1134-AB** antique brass  
 3 3/8" X 1 1/4"  
 3" center to center  
 Cast brass  
*Ornate Victorian bin pull*



**1143-PB**  
 3 3/4" wide, 1 1/2" high  
 3 1/4" center to center  
 Steel  
 Brass plated

Utility pulls



**1143-BK**  
 3 3/4" wide, 1 1/2" high  
 3 1/4" center to center  
 Steel  
 Flat black finish



**9140** Drawer / Bin Pull  
 4 1/4" wide  
 2 7/8" center to center  
 Cast iron  
 Black



**9139**  
 3 1/2" wide  
 2-15/16" center to center  
 Cast iron, black

Ornate cast iron drawer / bin pulls



**9141** Drawer / Bin Pull  
 3 3/8" wide  
 2 7/8" center to center  
 3/4" projection  
 Cast iron  
 Black



**9138** Drawer / Bin Pull  
 4" wide  
 3 1/4" center to center  
 Cast iron  
 Black

Contemporary pulls  
Solid brass  
In 5 finishes  
For cabinet drawers and doors



- 1427-PB polished brass
- 1427-PL lacquered brass
- 1427-PN polished nickel
- 1427-BN brushed nickel
- 1427-OB oil rubbed bronze
- 5 1/2" overall length
- 3 3/4" center to center

*Med.*



- 1425-PB polished brass
- 1425-PL lacquered brass
- 1425-PN polished nickel
- 1425-BN brushed nickel
- 1425-OB oil rubbed bronze
- 4 3/4" overall length
- 3" center to center

*Large*

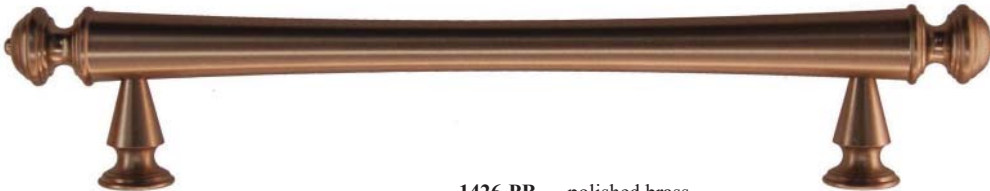

- 1426-PB polished brass
- 1426-PL lacquered brass
- 1426-PN polished nickel
- 1426-BN brushed nickel
- 1426-OB oil rubbed bronze
- 6 3/4" overall length
- 5" center to center
- Appliance pull*



*Extra Large*



- 1424-PB polished brass
- 1424-PN polished nickel
- 1424-BN brushed nickel
- 1424-OB oil rubbed bronze
- 8 7/8" overall length
- 7" center to center
- Appliance pull*

3 sizes: 3", 5", 7" center to center



LARGE BRASS HANDLES IN THE ARTS & CRAFTS STYLE

ALL STRAIGHT LINES AND RIGHT ANGLES

Classic elegance for the home

3 sizes - 5 finishes

Great-looking and sturdy

Appliance pulls

For drawers, cabinet doors



4" center



- 3201-PB** polished brass
- 3201-AB** antique brass
- 3201-PN** polished nickel
- 3201-BN** brushed nickel
- 3201-OB** oil rubbed bronze

Center to center: 4"  
 Overall length: 4 7/8"  
 Width of handle: 3/8" X 3/8"  
 Projection: 1 1/4", clearance: 7/8"  
 Bases: 7/8" X 7/8"  
 Solid brass



Large handle

8" center



- 3203-PB** polished brass
- 3203-AB** antique brass
- 3203-PN** polished nickel
- 3203-BN** brushed nickel
- 3203-OB** oil rubbed bronze

Center to center: 8"  
 Overall length: 8 7/8"  
 Width: 3/8" X 3/8"  
 Projection: 1 3/8", clearance: 1"  
 Bases: 7/8" X 7/8"  
 Solid brass



12" center

Extra large handle



- 3205-PB** polished brass
- 3205-AB** antique brass
- 3205-PN** polished nickel
- 3205-BN** brushed nickel
- 3205-OB** oil rubbed bronze

Center to center: 12"  
 Overall length: 12 7/8"  
 Width: 3/8" X 3/8"  
 Projection: 1 3/8", clearance: 1"  
 Bases: 7/8" X 7/8"  
 Solid brass

2" CC



For small drawers, cubbyholes, etc.

**1147-PB** polished brass  
**1147-PN** polished nickel  
**1147-OB** oil-rubbed bronze  
 2" center to center  
 Solid brass

3" CC



**1113-PB** polished brass  
**1113-BN** brushed nickel  
**1113-PN** polished nickel  
**1113-OB** oil rubbed bronze  
 3" center to center  
 Solid brass  
 With lugs at base



Can be used horizontally for drawers or vertically for cabinet doors

Mission / Arts & Crafts solid brass handles  
 Square horizontal bar is centered on bases

3 1/2" CC



**1148-PB** polished brass  
**1148-BN** brushed nickel  
**1148-PN** polished nickel  
**1148-OB** oil rubbed bronze  
 3 1/2" center to center  
 Solid brass

4" CC

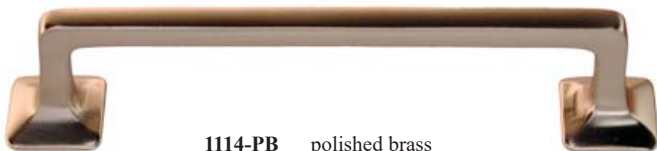

**1114-PB** polished brass  
**1114-BN** brushed nickel  
**1114-PN** polished nickel  
**1114-OB** oil rubbed bronze  
 4" center to center  
 With lugs at base



Ornate handles

**1309-PB** polished brass  
**1309-BN** brushed nickel  
**1309-PN** polished nickel  
**1309-OB** oil rubbed bronze  
**1309-AB** antique brass  
 3 7/8" long, 5/8" wide  
 3 1/8" center to center  
 Solid brass



**1133-PB** polished brass  
**1133-AB** antique brass  
 4 1/8" X 9/16"  
 3 1/4" center to center  
 Solid brass



Drawer and cabinet door handles  
 Can be used horizontally or vertically

Large



**1132-PB** polished brass  
**1132-AB** antique brass  
**1132-PL** lacquered polished brass  
**1132-PN** polished nickel  
**1132-BN** brushed nickel  
**1132-OB** oil rubbed bronze  
 4 3/4" long, 4 1/8" center to center  
 Solid brass

Screen door pull



Medium



**1130-PB** polished brass  
**1130-BN** brushed nickel  
**1130-PN** polished nickel  
**1130-OB** oil rubbed bronze  
 3" center to center  
 Cast brass

Small



**1131-PB** polished brass  
**1131-PN** polished nickel  
**1131-BN** brushed nickel  
**1131-OB** oil rubbed bronze  
 2 3/8" center to center  
 3" long, 5/8" projection  
 Cast brass



**1142-PB** polished brass  
**1142-PN** polished nickel  
 4 3/4" center to center  
 5 3/4" overall length  
 Solid brass

*Very large  
brass handle*



**1346-PB** polished brass  
**1346-PN** polished nickel  
**1346-OB** oil rubbed bronze  
**1346-BN** brushed nickel  
 3" center to center  
 Solid brass

Early 20th century solid brass handles in two sizes  
 For drawers, file cabinets, display cases, etc.  
 Oval horizontal bar set off-center to bases

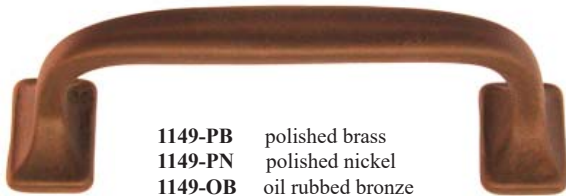

**1149-PB** polished brass  
**1149-PN** polished nickel  
**1149-OB** oil rubbed bronze  
**1149-BN** brushed nickel  
 3 1/2" center to center  
 Solid brass



**1335-PB** polished brass  
**1335-PN** polished nickel  
 4" center to center  
 5" tall, 7/8" wide  
 7/8" projection  
 Solid brass  
*For cabinet doors (vertical)  
 and for drawers (horizontal)*

Art Deco / moderne

3" CC



*Small*

**1331-PB** polished brass  
**1331-PN** polished nickel  
 3" center to center  
 7/8" projection  
 Solid brass

4" CC



*Medium*

**1333-PB** polished brass  
**1333-PN** polished nickel  
 4" center to center  
 7/8" projection  
 Solid brass

4 1/2" CC



*Large*

**1334-PB** polished brass  
**1334-PN** polished nickel  
 4 1/2" center to center  
 7/8" projection  
 Solid brass

Art Deco and moderne handles  
 In two finishes: polished nickel and polished brass

3 1/2" CC



**1332-PB** polished brass  
**1332-PN** polished nickel  
 3 1/2" center to center  
 7/8" projection  
 Solid brass

1 1/2" CC



**1330-PB** polished brass  
**1330-PN** polished nickel  
 1 1/2" center to center  
 7/8" projection  
 Solid brass

*Small*



**1409-PB** polished brass  
**1409-PL** lacquered brass  
**1409-AB** antique brass  
**1409-BN** brushed nickel  
**1409-PN** polished nickel  
**1409-OB** oil rubbed bronze  
 4" overall length  
 3 1/2" center to center  
 Solid brass

*Medium*



**1410-PB** polished brass  
**1410-PL** lacquered brass  
**1410-AB** antique brass  
**1410-BN** brushed nickel  
**1410-PN** polished nickel  
**1410-OB** oil rubbed bronze  
 4" center to center  
 4 3/4" overall length, 1 3/16" wide  
 Solid brass

*Large*



**1412-PB** polished brass  
**1412-PL** lacquered brass  
**1412-AB** antique brass  
**1412-BN** brushed nickel  
**1412-PN** polished nickel  
**1412-OB** oil rubbed bronze  
 4 3/8" center to center  
 5" overall length, 1 3/16" wide  
 Solid brass

*A larger size than the other 2 similar handles enabling a better grip*

Bar handles for sashes, windows, file cabinets, drawers



**1411-PB** polished brass  
**1411-PN** polished nickel  
 3 3/4" center to center  
 4 1/4" overall length, 1 1/4" wide  
 Solid brass



**6100**  
 5 1/2" wide  
 3 1/2" center to center  
 Zinc diecast & Bakelite



**6101**  
 6" wide  
 4 1/4" center to center  
 Zinc diecast & Bakelite

**Bakelite and die-cast metal handles**  
 for waterfall, Depression, 1930's furniture, etc.  
 Metal parts in antique brass finish



**6102**  
 4 3/4" wide  
 4" center to center  
 Zinc diecast & Bakelite



**6103**  
 5 1/8" wide  
 4 1/2" center to center  
 Zinc diecast & Bakelite



Sold  
in  
pairs

**1179-PB** polished brass  
**1179-AB** antique brass  
15/16" diameter  
Stamped brass  
*Finishing washers - standard  
back plates for knobs and bail  
sets*



**1189-PB** polished brass  
**1189-AB** antique brass  
1 1/8" diameter  
Stamped brass  
*Pierced Rosettes, "fancy"  
back plate for bail sets,  
ornate knobs, etc.*



**1185-PB**  
2" center to center  
Wrought brass handle  
*A smaller version of #1180-PB*

2" C.C.



**1180-PB** polished brass  
**1180-AB** antique brass  
3" center to center  
Wrought brass handle



**1181-PB** polished brass  
**1181-AB** antique brass  
3" center to center  
Wrought brass handle



**1182-PB** polished brass  
**1182-AB** antique brass  
3" center to center  
Wrought brass handle  
*Contoured plain handle*



**1183-PB**  
3" center to center  
Wrought brass handle



**1190-PB** polished brass  
**1190-AB** antique brass  
3" center to center  
Cast brass handle



**1191-PB** polished brass  
**1191-AB** antique brass  
3" center to center  
Cast brass handle



**1192-PB** polished brass  
**1192-AB** antique brass  
3" center to center  
Cast brass handle  
*With pierced rosettes*

2 1/2" C.C.



**1145-PB**  
2 1/2" center to center  
Solid brass  
*Contoured flat handle  
with special turned posts*

2 swan-neck bail pulls with turned posts

3" C.C.



**1146-PB**  
3" center to center  
Solid brass  
*Contoured flat handle  
with special turned posts*

*Small*



**1317-PB** polished brass  
**1317-AB** antique brass  
 2 1/2" center to center  
 Posts 1 1/8" dia.  
 Solid brass

*Medium*



**1318-PB** polished brass  
**1318-AB** antique brass  
 3" center to center  
 Posts 1 1/8" dia.  
 Solid brass

*Large*



**1319-PB** polished brass  
**1319-AB** antique brass  
 3 1/2" center to center  
 Posts 1 3/8" dia.  
 Solid brass

**3 Colonial Revival drawer pulls**  
 With square handles and hexagonal posts



**1011-PB**  
 8-32 thread  
 1 1/8" long  
 Includes 2 threaded studs and 2 nuts  
 Sold in pairs

*Stud and Nuts and posts for pulls can be bought by themselves*



**1186-PB**  
 1" plate dia.  
 Solid brass  
 Includes threaded studs & nuts  
 Round posts for handles, bails etc.  
 Sold in pairs

*Oval posts*



**1320-PB**  
 1 1/8" X 1 1/2"  
 Solid brass  
 Includes threaded studs & nuts  
 Oval posts for handles, bails etc.  
 Rope pattern  
 Sold in pairs

*Medium*



**1321-PB** polished brass  
**1321-AB** antique brass  
 3" center to center  
 Oval rosettes: 1 1/8" X 1 1/2"  
 Solid brass  
 Rope pattern

*Large*



**1322-PB** polished brass  
**1322-AB** antique brass  
 3 1/2" center to center  
 Oval rosettes: 1 1/8" X 1 1/2"  
 Solid brass  
 Rope pattern

**2 swan-neck pulls with oval rosettes**

*Small*



**1325-PB** polished brass  
**1325-AB** antique brass  
**1325-PL** lacquered brass  
 2 1/2" center to center  
 Rosettes: 1" dia.  
 Solid brass

*Medium*



**1326-PB** polished brass  
**1326-AB** antique brass  
**1326-PL** lacquered brass  
 3" center to center  
 Rosettes: 1" dia.  
 Solid brass

*Large*



**1327-PB** polished brass  
**1327-AB** antique brass  
**1327-PL** lacquered brass  
 3 1/2" center to center  
 Rosettes: 1" dia.  
 Solid brass

**3 swan-neck pulls with beaded center and round rosettes in 3 finishes**



*Handle with a stop, swings out one way only*



*Lifting handle for chests, boxes, and furniture*

**1140-PB** polished brass  
**1140-AB** antique brass  
 4 1/2" center to center  
 6" overall length  
 Solid brass

*Small*



**1125-PB**  
 2 1/2" center to center  
 Rosettes: 1" dia.  
 Solid brass  
 With "bead" at center of bail

*Medium*



**1126-PB**  
 3" center to center  
 Rosettes: 1" dia.  
 Solid brass  
 With "bead" at center of bail

*Large*



**1127-PB**  
 3 1/2" center to center  
 Rosettes: 1" dia.  
 Solid brass  
 With "bead" at center of bail

3 swan-neck pulls with beaded center in 3 finishes

2" C.C.



**1119-PB**  
 2" center to center  
 Rosettes: 1" dia.  
 Solid brass

2 1/2" CC



**1120-PB** polished brass  
**1120-AB** antique brass  
 2 1/2" center to center  
 Rosettes: 1" dia.  
 Solid brass

3" CC



**1121-PB** polished brass  
**1121-AB** antique brass  
 3" center to center  
 Rosettes: 1" dia.  
 Solid brass

3 1/2" CC



**1122-PB** polished brass  
**1122-AB** antique brass  
 3 1/2" center to center  
 Rosettes: 1 3/16" dia.  
 Solid brass

4" CC



**1123-PB** polished brass  
**1123-AB** antique brass  
 4" center to center  
 Post plate: 1 3/16" dia.  
 Solid brass

Swan-neck drawer pulls in 5 sizes and 2 finishes

Lg.



**1155-PB** polished brass  
**1155-PN** polished nickel  
**1155-AB** antique brass  
 Plate: 4 1/4" X 1 1/2"  
 3" center to center  
 Stamped brass  
 With square posts  
 Eastlake style



**1150-PB** polished brass  
**1150-AB** antique brass  
 Plate: 4 1/8" X 2"  
 3" center to center  
 Stamped brass

Sm.



**1156-PB** polished brass  
**1156-PN** polished nickel  
**1156-AB** antique brass  
 Plate: 3 1/4" X 1 1/2"  
 2 1/2" center to center  
 Stamped brass  
 With square posts  
 Eastlake style



**1151-PB** polished brass  
**1151-AB** antique brass  
 Plate: 4 1/2" X 2 1/4"  
 3" center to center  
 Stamped brass

*Often overlooked fact: Eastlake furniture mostly used polished nickel hardware*



**1153-PB** polished brass  
**1153-PN** polished nickel  
 Plate: 5" X 1 7/8"  
 3" center to center  
 Stamped brass  
 Eastlake style



**1154-PB** polished brass  
**1154-AB** antique brass  
 Plate: 4 1/8" X 1 3/4"  
 3" center to center  
 Stamped brass

Stamped brass Victorian and American Oak furniture pulls



**1158-PB** polished brass  
**1158-AB** antique brass  
 Plate: 3 5/8" X 1 5/8"  
 3" center to center  
 Stamped brass



**1157-PB** polished brass  
**1157-AB** antique brass  
 Plate: 4 1/8" X 1 3/4"  
 3" center to center  
 Stamped brass



**1152-PB** polished brass  
**1152-AB** antique brass  
 Plate: 4 3/4" X 2 1/4"  
 3" center to center  
 Stamped brass



UPC BAR-CODE LABELS

Would UPC bar-code labels on your products help you with your operation at your point of sale? We can put our UPC bar-code labels on products for you. Please contact us for more information.



**1100-PB**  
Plate: 4 3/8" X 1 3/4"  
3" center to center  
Cast brass



**1105-PB** polished brass  
**1105-AB** antique brass  
Plate: 4 3/8" X 1 5/8"  
3" center to center  
Cast brass



**1101-PB** polished brass  
**1101-AB** antique brass  
Plate: 4 3/8" X 1 7/8"  
3" center to center  
Cast brass



**1106-PB** polished brass  
**1106-AB** antique brass  
Plate: 3 3/4" X 1 7/16"  
3" center to center  
Cast brass

Cast brass Victorian and American Oak furniture pulls



**1102-PB**  
**1102-AB**  
Plate: 4 3/8" X 1 7/8"  
3" center to center  
Cast brass



**1107-PB** polished brass  
**1107-AB** antique brass  
3" center to center  
Plate: 4 3/8" wide, 2" high  
Forged brass  
*Drawer pull*



**1103-PB**  
Plate: 3 3/4" X 2"  
3" center to center  
Cast brass



Sold in pairs



**1178-PB** polished brass  
**1178-AB** antique brass  
Stem 1 1/8" long  
Brass plated  
*Standard eyelet posts for drop handles*

**1187-PB** polished brass  
**1187-AB** antique brass  
7/8" projection  
Solid brass  
*Fancy, ornate posts for Victorian pulls. Can be used with any back plate or handle on pages 49-51*



**1104-PB** polished brass  
**1104-AB** antique brass  
Plate: 3 7/8" X 1 7/8"  
3" center to center  
Cast brass



Sold in pairs



**1188-PB** polished brass  
**1188-PN** polished nickel  
5/8" projection  
Solid brass  
*Square posts for Victorian Eastlake pulls*

**1198-PB**  
3/4" projection  
Shanks tapped for 8-32 thread  
Solid brass  
*Come with screws.*

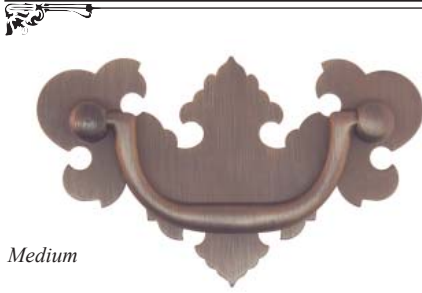

Medium

**1171-PB** polished brass  
**1171-AB** antique brass  
 2 1/2" center to center  
 Plate: 3 1/2" X 2 1/8"  
 Solid brass



Medium

**1467-PB**  
 2 1/2" center to center  
 Plate: 3 1/4" X 2 1/2"  
 Solid brass



Large

**1170-PB** polished brass  
**1171-AB** antique brass  
 3" center to center  
 Plate: 4 1/8" X 2 1/2"  
 Solid brass



Large

**1468-PB**  
 3" center to center  
 Plate: 4 1/8" X 3 1/4"  
 Solid brass

Chippendale style willow brasses

Heavy-stamped plates

For Chippendale style keyhole plates see p. 68



Small

**1458-PB**  
 2" center to center  
 Plate: 2 1/2" X 1 5/8"  
 Solid brass



Small

**1493-PB**  
 2" center to center  
 Plate: 2 3/4" X 1 7/8"  
 Solid brass  
 Openwork plate



Medium

**1459-PB**  
 2 1/2" center to center  
 Plate: 3" X 2"  
 Solid brass



Medium

**1494-PB**  
 2 1/2" center to center  
 Plate: 3 3/8" X 2 3/8"  
 Solid brass  
 Openwork plate



Large

**1460-PB**  
 3" center to center  
 Plate: 3 5/8" X 2 1/2"  
 Solid brass



Large

**1495-PB**  
 3" center to center  
 Plate: 4 1/8" X 2 7/8"  
 Solid brass  
 Openwork plate

Available with or without lacquer



Large

**1173-PB** polished brass  
**1173-PL** lacquered brass  
 3" center to center  
 Plate: 4" X 3"  
 Solid brass  
 Chippendale style pull with openwork plate (pierced)

**Chippendale style willow brasses**  
 Heavy-stamped plates  
 For Chippendale style keyhole plates see p. 68



Small

**1461-PB** polished brass  
**1461-AB** antique brass  
 2" center to center  
 Plate: 3 1/8" x 2 1/4"  
 Solid brass



Medium

**1462-PB** polished brass  
**1462-AB** antique brass  
 2 1/2" center to center  
 Plate: 3 3/4" X 2 3/4"  
 Solid brass



Large

**1463-PB** polished brass  
**1463-AB** antique brass  
 3" center to center  
 Plate: 4 1/2" X 3 3/8"  
 Solid brass



Small

**1453-PB**  
 2" center to center  
 Plate: 2 5/8" X 1 3/4"  
 Stamped brass



Medium

**1454-PB**  
 2 1/2" center to center  
 Plate: 3 1/8" X 2 1/4"  
 Stamped brass

**Oval pulls with 2 patterns**  
 Urn and sunburst



Small

**1175-PB** polished brass  
**1175-AB** antique brass  
 2" center to center  
 Plate: 1 3/4" X 2 1/2"  
 Stamped brass plate  
 Cast brass handle, brass posts



Medium

**1176-PB** polished brass  
**1176-AB** antique brass  
 2 1/2" center to center  
 Plate: 3" X 2 3/8"  
 Stamped brass plate  
 Cast brass handle, brass posts



Large

**1177-PB** polished brass  
**1177-AB** antique brass  
 3" center to center  
 Plate: 3 3/4" X 2 3/4"  
 Stamped brass plate  
 Cast brass handle, brass posts



**1165-PB** polished brass  
**1165-AB** antique brass  
 Plate: 3" wide, 1 7/8" high  
 Stamped brass  
 Single post



**1166-PB** polished brass  
**1166-AB** antique brass  
 Plate: 3" wide, 1 1/2" high  
 Stamped brass  
 Single post



**1169-PB** polished brass  
**1169-AB** antique brass  
 Plate: 2 3/4" wide, 2 1/8" high  
 Stamped brass  
 Single post



**1195-PB** polished brass  
**1195-AB** antique brass  
 Plate: 2 1/8" wide, 2 1/4" high  
 Stamped brass  
 Single post



**1194-PB** polished brass  
**1194-AB** antique brass  
 Plate: 2 1/2" wide, 1 3/8" high  
 Stamped brass  
 Single post

Pulls with a single post at center of plate

Sm.



**1168-PB** polished brass  
**1168-AB** antique brass  
 Plate: 1 5/8" dia.  
 Stamped brass back plate  
 Cast brass ring  
 Single post

Lg.



**1167-PB** polished brass  
**1167-AB** antique brass  
 Plate: 2" dia.  
 Stamped brass back plate  
 Cast brass ring  
 Single post

2 ring pulls with a single post at center of plate

Sm.



**1450-PB**  
 Plate: 1 1/2" dia.  
 Stamped brass  
 Single post

Med.



**1451-PB**  
 Plate: 1 3/4" dia.  
 Stamped brass  
 Single post

Lg.



**1452-PB**  
 Plate: 2" dia.  
 Stamped brass  
 Single post

3 ring pulls with urn pattern and single post at top of plate  
 See also 2 oval pulls with the same pattern on previous page

Small



**1455-PB**  
 Plate: 2 1/2" X 1 5/8"  
 Ring: 1 1/2" wide  
 Solid brass  
 Single post

Medium



**1456-PB**  
 Plate: 3" X 2"  
 Ring: 1 3/4" wide  
 Solid brass  
 Single post

Chippendale style willow brasses  
 Single post with ring pulls  
 Heavy-stamped plates

Sm.



**1249-PB**  
 Bow: 3/4" wide  
 Base: 3/8" dia.  
 Solid brass

Med.



**1251-PB**  
 Bow: 1" wide  
 Base: 1/2" dia.  
 Solid brass

Lg.



**1250-PB**  
 Bow: 1 1/2" wide  
 Back plate: 1 1/8" dia.  
 Solid brass

Bow pulls (Dutch Pulls) in 3 sizes



**1281-PB** polished brass  
**1281-PN** polished nickel  
**1281-AB** antique brass  
 Plate: 1 1/2" wide, 1 3/4" high  
 1 3/4" ring dia.  
 Solid brass



**1282-PB** polished brass  
**1282-PN** polished nickel  
 Plate: 2 1/6" wide, 2 1/16" high  
 1 1/2" ring dia.  
 Solid brass

Eastlake style ring pulls  
 In polished brass and polished nickel finishes

Often overlooked fact: Eastlake furniture mostly used polished nickel hardware

Smaller



**1277-PB** polished brass  
**1277-PN** polished nickel  
 1 3/4" back plate dia.  
 1 3/4" ring dia.  
 Solid brass

Larger



**1278-PB** polished brass  
**1278-PN** polished nickel  
 2 1/2" back plate dia.  
 1 3/4" ring dia.  
 Solid brass



**1260-PB** polished brass  
**1260-AB** antique brass  
 Lion head: 1 5/8" X 2"  
 1 1/2" ring dia.  
 Solid brass  
 Duncan Phyfe style  
 Lion Head Pull



**1259-PB** polished brass  
**1259-AB** antique brass  
**1259-PN** polished nickel  
 Plate: 2" wide  
 1 5/8" ring dia.  
 Solid brass

PENDANT PULLS



**1470-1484-PB**  
Plate: 1 1/2" dia.  
Drop: 1 3/4"  
*Medium*



**1470-1483-PB**  
Plate: 1 1/2" dia.  
Drop: 1 7/8"  
*Medium*



**1471-1480-PB**  
Plate: 1 3/4" wide  
Drop: 1 3/4"  
*Small*



**1472-1481-PB**  
Plate: 2 1/4" wide  
Drop: 2"  
*Large*



**1470-1485-PB**  
Plate: 1 1/2" dia.  
Drop: 2"  
*Medium*



**1470-1490-PB**  
Plate: 1 1/2" dia.  
Drop: 2 1/8"  
*Medium*



**1472-1487-PB**  
Plate: 2 1/4" wide  
Drop: 1 3/8"  
*Large*



**1472-1485-PB**  
Plate: 2 1/4" wide  
Drop: 2"  
*Large*

Colonial Revival / Depression Era  
Solid brass pendant pulls  
More pendant/backplate combinations are possible  
See next page



**1469-1482-PB**  
Plate: 1 3/16" dia.  
Drop: 1 7/8"  
*Small*



**1473-1489-PB**  
Plate: 1 3/8" dia.  
Drop: 1 3/4"  
*Small*



**1474-1487-PB**  
Plate: 1 7/8" dia.  
Drop: 1 3/8"  
*Large*



**1474-1488-PB**  
Plate: 1 7/8" dia.  
Drop: 1 3/4"  
*Large*



**1474-1486-PB**  
Plate: 1 7/8" dia.  
Drop: 2 1/4"  
*Large*





Good Hardware  
at Good Prices

*Sm.*



**1471-PB Plate**  
1 3/4" wide, 7/8" high

*Lg.*



**1472-PB Plate**  
2 1/4" wide, 1 1/8" high

11 pendants and 6 back plates  
for Colonial Revival drop pulls  
Mix and match any plate and pendant

*Med.*



**1473-PB Plate**  
1 3/8" dia.

*Sm.*



**1469-PB Plate**  
1 3/16" dia.

*Lg.*



**1474-PB Plate**  
1 7/8" dia.

*Med.*



**1470-PB Plate**  
1 1/2" dia.



**1489-PB**  
1" wide  
1 3/4" drop



**1480-PB**  
1 1/4" wide  
1 3/4" drop



**1481-PB**  
1 1/2" wide  
2" drop



**1482-PB**  
3/4" wide  
1 7/8" drop



**1483-PB**  
1" wide  
1 7/8" drop



**1486-PB**  
1 1/8" wide  
2 1/4" drop



**1485-PB**  
1 1/2" wide  
2" drop



**1490-PB**  
1 1/4" wide  
2 1/8" drop



**1484-PB**  
1 1/8" wide  
1 3/4" drop



**1487-PB**  
2" wide  
1 3/8" drop



**1488-PB**  
1 3/4" wide  
1 3/4" drop



**1141-PB** polished brass  
**1141-PL** lacquered polished brass  
**1141-PN** polished nickel  
**1141-BN** brushed nickel  
**1141-OB** oil rubbed bronze  
 1 7/16" X 1 3/4"  
 Solid brass  
*Flush (recessed) ring pull*



**1255-PB** polished brass  
**1255-PN** polished nickel  
 Pendant 1 1/2" long  
 1" back plate dia.  
 Solid brass



**1256-PB** polished brass  
**1256-PN** polished nickel  
 Pendant 2" long  
 1 1/4" back plate dia.  
 Solid brass



**1276-PB**  
 Pendant 2" long  
 Plate: 2 3/8" X 2 1/4"  
 Solid brass  
*Chased plate*

Colonial Revival "tear drop" pulls



Large

**1257-PB** polished brass, ebonized  
**1257-AB** antique brass, ebonized  
**1257-W-PB** polished brass, walnut  
 Conic rosette: 1 5/8" dia.  
 Pendant: 3" long, 1 1/8" dia.



Small

**1267-PB** polished brass, ebonized  
**1267-AB** antique brass, ebonized  
**1267-W-PB** polished brass, walnut  
 Pendant: 2 1/2" long, 7/8" dia.  
 Conic rosette: 1 1/4" dia.

Eastlake style Victorian drop pulls



Small



Large

**1270-PB** polished brass  
**1270-AB** antique brass  
 Pendant: 1 1/2" long, 7/8" dia.  
 Conic rosette: 1 1/4" dia.  
*Ebonized knob*

**1269-PB** polished brass  
**1269-AB** antique brass  
 Pendant: 2" long, 1 1/4" dia.  
 Conic rosette: 1 5/8" dia.  
*Ebonized knob*

Walnut knob



Smaller

**1258-W-PB**  
 1" dia.  
 1 1/4" projection  
 Walnut wood with brass top  
 Polished brass

Walnut knob



Larger

**1268-W-PB**  
 1 3/8" dia.  
 1 1/4" projection  
 Walnut wood with brass top  
 Polished brass  
 Unfinished walnut

Eastlake Victorian wood knobs with brass tops  
 2 sizes, 2 woods, 2 finishes  
 Screw welded to brass top and wedged to wood part  
 exactly as in the original knobs

Ebonized knob



Smaller

**1258-PB** polished brass  
**1258-AB** antique brass  
 1" dia.  
 1 1/4" projection  
 Ebonized wood with brass top  
 The brass top is available  
 in 2 finishes

Ebonized knob



Larger

**1268-PB** polished brass  
**1268-AB** antique brass  
 1 3/8" dia.  
 1 1/4" projection  
 Ebonized wood with brass top  
 The brass top is available  
 in 2 finishes



1281



1282

More Eastlake hardware  
 Ring pulls and matching keyhole plates

Often overlooked fact: Eastlake furniture mostly used polished nickel hardware



1204



1213



**1340-PB** polished brass  
**1340-AB** antique brass  
 Diameter: 1 1/8"  
 Projection: 1"  
 Base dia.: 9/16"  
 Solid brass  
 Smaller

French style brass knobs  
 Come in 2 sizes and 2 finishes



**1341-PB** polished brass  
**1341-AB** antique brass  
 Diameter: 1 1/2"  
 Projection: 1 1/4"  
 Base dia.: 11/16"  
 Solid brass  
 Larger

Small



**1291-PB** polished brass  
**1291-AB** antique brass  
 1 1/4" dia.  
 13/16" projection  
 Cast brass



**1241-PB** polished brass  
**1241-AB** antique brass  
 1 1/4" dia.  
 1" projection  
 Cast brass

Large



**1243-PB** polished brass  
**1243-AB** antique brass  
 1 1/2" dia.  
 1" projection  
 Cast brass



**1292-PB** polished brass  
**1292-AB** antique brass  
 1 1/2" dia.  
 7/8" projection  
 Cast brass

Ornate American Oak Victorian knobs - come with the finishing washer shown below  
 Can also be used with the pierced rosette shown on this page

Small



**1242-PB**  
 1 1/4" dia.  
 1" projection  
 Cast brass



**1244-PB** polished brass  
**1244-AB** antique brass  
 1 1/4" dia.  
 7/8" projection  
 Cast brass

Large



**1240-PB** polished brass  
**1240-AB** antique brass  
 1 1/2" dia.  
 1" projection  
 Cast brass



**1179-PB** polished brass  
**1179-AB** antique brass  
 15/16" dia.  
 Stamped brass  
*Finishing washer is included with all knobs on this side  
 Can also be ordered separately  
 Sold in pairs*



**1189-PB** polished brass  
**1189-AB** antique brass  
 1 1/8" diameter  
 Stamped brass  
*Pierced Rosettes, "fancy" back plates for bail sets, ornate knobs, etc.  
 Sold in pairs*

Small



**1294-PB**  
1" dia.  
7/8" projection  
Stamped brass

Side  
view



**1299-PB** polished brass  
**1299-AB** antique brass  
1" dia.  
5/8" projection  
Back plate: 1" dia.

Medium



**1295-PB**  
1 1/4" dia.  
1" projection  
Stamped brass



**1298-PB** polished brass  
**1298-AB** antique brass  
1 1/4" dia.  
3/4" projection  
Back plate: 1 1/4" dia.

Colonial Revival style knobs  
Pattern available in 3 sizes

Sheraton style knobs with matching plates  
Available in 2 finishes and 4 sizes

Large



**1296-PB**  
1 1/2" dia.  
1 1/8" projection  
Stamped brass



**1297-PB** polished brass  
**1297-AB** antique brass  
1 5/8" dia.  
1 1/16" projection  
Back plate: 1 5/8" dia.  
Stamped brass



**1246-PB** polished brass  
**1246-AB** antique brass  
**1246-PN** polished nickel  
1" dia. , 1" projection  
Cast brass  
*Colonial revival,  
Depression era*



**1300-PB** polished brass  
**1300-AB** antique brass  
2" dia.  
1 3/8" projection  
Back plate: 2" dia.  
Stamped brass

Colonial Revival / Depression Era  
Early 20th century

*Small*



**1237-PB** polished brass  
**1237-AB** antique brass  
**1237-OB** oil rubbed bronze  
**1237-PN** polished nickel  
**1237-BN** brushed nickel  
**1237-BK** black  
 1" dia.  
 7/8" projection

*Medium*



**1238-PB** polished brass  
**1238-AB** antique brass  
**1238-OB** oil rubbed bronze  
**1238-PN** polished nickel  
**1238-BN** brushed nickel  
**1238-BK** black  
 1 1/4" dia.  
 1 1/8" projection

3 solid brass spun knobs

*Large*



**1239-PB** polished brass  
**1239-AB** antique brass  
**1239-OB** oil rubbed bronze  
**1239-PN** polished nickel  
**1239-BN** brushed nickel  
**1239-BK** black  
 1 1/2" dia.  
 1 3/8" projection

*Small*



**1235-PB** polished brass  
**1235-OB** oil rubbed bronze  
**1235-PN** polished nickel  
**1235-BN** brushed nickel  
**1235-PC** polished chrome  
**1235-BC** brushed chrome  
**1235-BK** black  
 1" X 5/8" ,  
 1" projection

2 solid brass oval knobs

*Large*



**1236-PB** polished brass  
**1236-OB** oil rubbed bronze  
**1236-PN** polished nickel  
**1236-BN** brushed nickel  
**1236-PC** polished chrome  
**1236-BC** brushed chrome  
 1 1/4" X 7/8"  
 1 1/4" projection



**1231-PB**  
 5/8" dia.  
 5/8" proj.



**1232-PB**  
 3/4" dia.  
 3/4" proj.

4 solid brass knobs with matching back plates  
 come with a machine screw and hanger bolt



**1233-PB**  
 1" dia.  
 1" proj.



**1234-PB**  
 1 1/4" dia.  
 1 1/4" proj.



*Small*



**1435-PB** polished brass  
**1435-PL** lacquered brass  
**1435-PN** polished nickel  
**1435-BN** brushed nickel  
**1435-OB** oil rubbed bronze  
 1" dia.  
 1 1/16" projection

*Same pattern in two sizes*

*Large*



**1436-PB** polished brass  
**1436-PL** lacquered brass  
**1436-PN** polished nickel  
**1436-BN** brushed nickel  
**1436-OB** oil rubbed bronze  
 1 1/4" dia.  
 1 3/16" projection

*Small*



**1432-PB** polished brass  
**1432-PL** lacquered brass  
**1432-PN** polished nickel  
**1432-BN** brushed nickel  
**1432-OB** oil rubbed bronze  
 1" dia.  
 1" projection

*Same pattern in two sizes*

*Large*



**1433-PB** polished brass  
**1433-PL** lacquered brass  
**1433-PN** polished nickel  
**1433-BN** brushed nickel  
**1433-OB** oil rubbed bronze  
 1 1/4" dia.  
 1" projection

Contemporary knobs  
 Classic elegance  
 Solid brass - In 5 finishes

*Small*



**1438-PB** polished brass  
**1438-PL** lacquered brass  
**1438-PN** polished nickel  
**1438-BN** brushed nickel  
**1438-OB** oil rubbed bronze  
 1" dia.  
 1 1/8" projection

*Same pattern in two sizes*

*Large*



**1439-PB** polished brass  
**1439-PL** lacquered brass  
**1439-PN** polished nickel  
**1439-BN** brushed nickel  
**1439-OB** oil rubbed bronze  
 1 1/4" dia.  
 1 3/16" projection



**1434-PB** polished brass  
**1434-PL** lacquered brass  
**1434-PN** polished nickel  
**1434-BN** brushed nickel  
**1434-OB** oil rubbed bronze  
 1 1/4" dia.  
 1" projection



**1437-PB** polished brass  
**1437-PL** lacquered brass  
**1437-PN** polished nickel  
**1437-BN** brushed nickel  
**1437-OB** oil rubbed bronze  
 1 3/4" wide  
 1 3/8" projection



*Oblong octagonal knob*

**1336-PB** polished brass  
**1336-PN** polished nickel  
 1 1/4" X 7/8"  
 7/8" projection  
 Solid brass

Art Deco knobs



*Round knob with rings*

**1337-PB** polished brass  
**1337-PN** polished nickel  
 1 3/16" dia.  
 1 1/8" projection  
 Solid brass



**1245-PB** polished brass  
**1245-PN** polished nickel  
 1 1/8" dia. , 3/4" projection  
 Stamped brass  
*Simple knob for Hoosiers, kitchen cabinets, etc.*



**1248-PB**  
 1 5/16" dia. , 1 1/8" projection  
 1" back plate dia.  
 Stamped brass  
*Spool cabinet knob  
 With split pin attachment*



**1221-PB**  
 3/8" dia.  
 7/16" projection



**1222-PB** polished brass  
**1222-PN** polished nickel  
 1/2" dia.  
 1/2" projection  
*In 2 finishes*

Solid brass "bookcase" knobs  
 Come with machine screw and hanger bolt



**1223-PB**  
 5/8" dia.  
 1/2" projection



**1224-PB**  
 3/4" dia.  
 9/16" projection



*With concentric rings on face of knobs*



**1226-PB**  
 5/8" dia.  
 1/2" projection

**1228-PB**  
 7/8" dia.  
 1/2" projection



**1229-PB** polished brass  
**1229-PN** polished nickel  
 5/8" dia. , 9/16" projection  
 Solid brass  
*Bookcase Knob  
 In 2 finishes*



**1230-PB** polished brass  
**1230-BK** flat black  
 3/4" dia.  
 5/8" projection  
*Mushroom shaped  
 In 2 finishes*







**1266-PB** polished brass  
 3/4" X 3/4"  
 Heavy stamped brass  
*Square back plate  
 for use with knob #1261 etc.*



*Small*

**1261-PB**  
 3/4" square  
 3/4" projection  
 Solid brass  
 Polished brass



*Medium*

**1262-PB** polished brass  
**1262-BN** brushed nickel  
**1262-PN** polished nickel  
**1262-OB** oil rubbed bronze  
 1" square, 7/8" projection  
 Solid brass



*Large*

**1263-PB** polished brass  
**1263-BN** brushed nickel  
**1263-PN** polished nickel  
**1263-OB** oil rubbed bronze  
 1 1/4" square, 1" projection  
 Solid brass

Mission / Arts & Crafts solid brass pyramid knobs



**1020-AC**  
 1 3/16" X 1 3/16"  
 Base: 13/16" X 13/16"  
 15/16" projection  
 Forged brass  
 Antique copper finish  
 Hammered surface



**6104**  
 2" dia.  
 3/4" projection  
 Bakelite & Zinc diecast



**9250**  
 1" dia.  
 1" projection  
 Cast iron  
 Painted black  
*Disk knob*



*Small*

**9262**  
 1" square  
 7/8" projection  
 Cast iron  
 Painted black  
*Pyramid knob*



**9252**  
 1 3/16" dia.  
 1 3/16" projection  
 Iron  
 Painted black

*Large*



**9253**  
 1 3/8" dia.  
 1 3/8" projection  
 Iron  
 Painted black



**1201-PB** polished brass  
**1201-AB** antique brass  
 2 1/4" X 1 1/8"  
 Cast brass



**1202-PB** polished brass  
**1202-AB** antique brass  
 2" X 1 1/2"  
 Cast brass



**1212-PB** polished brass  
**1212-AB** antique brass  
 2 1/8" wide, 1 3/8" high  
 Forged brass



**1207-PB** polished brass  
**1207-AB** antique brass  
 2" X 1 1/4" dia.  
 Stamped brass



**1208-PB** polished brass  
**1208-AB** antique brass  
 1 7/8" X 1 1/8" dia.  
 Stamped brass



**1213-PB** polished brass  
**1213-PN** polished nickel  
 Overall height and width: 2 1/8"  
 Length of side: 1 1/2"  
 Solid brass  
*Eastlake style*

2 Eastlake style keyhole plates

*Note: Eastlake furniture mostly used polished nickel hardware*



**1204-PB** polished brass  
**1204-PN** polished nickel  
 1" wide, 1 1/2" high  
 Stamped brass  
*Eastlake style*



**6547-PB**  
 3 3/4" long  
 1 3/8" high  
 Heavy stamped brass

*Premium quality plate for roll top desks  
 Made of thick brass sheet*



*Large keyhole plate*

**1205-PB**  
 5 1/2" long, 1 1/2" high  
 Cast brass



**1203-PB**  
 2 3/8" X 2 1/4"  
 Wrought brass  
*Chased plate  
 Colonial Revival*



**1209-PB** polished brass  
**1209-AB** antique brass  
 1" dia.  
 Stamped brass  
*Round*



**1210-PB** polished brass  
**1210-AB** antique brass  
 1 1/2" X 1 1/8"  
 Stamped brass  
*Horizontal oval*



**1211-PB** polished brass  
**1211-AB** antique brass  
 1 1/8" X 1 1/2"  
 Stamped brass  
*Vertical oval*



**1218-PB** polished brass  
**1218-AB** antique brass  
 1 3/8" dia.  
 Stamped brass  
*Round*



**1219-PB** polished brass  
**1219-AB** antique brass  
 1 1/2" X 1 1/8"  
 Stamped brass  
*Horizontal oval*



**1220-PB** polished brass  
**1220-AB** antique brass  
 1" X 1 5/16"  
 Stamped brass  
*Vertical oval*



**1217-PB** polished brass  
**1217-AB** antique brass  
 1 1/16" X 1 5/8"  
 Stamped brass

Colonial Revival keyhole plates



**1023-AC**  
 1 5/8" X 1"  
 Forged brass  
 Antique copper finish  
*Rectangular keyhole plate*



**1214-PB**  
 1 15/16" X 7/8"  
 Solid brass, heavy stamped  
*Diamond-shaped*



**1216-PB**  
 1 15/16" X 7/8"  
 Solid brass, heavy stamped  
*Rectangular*

Mission style keyhole plates



**1172-PB** polished brass  
**1172-AB** antique brass  
 Plate: 3 1/2" X 2 1/8"  
 Solid brass



**1466-PB**  
 3 1/4" X 2 1/2"  
 Solid brass



**1457-PB**  
 Plate: 2 1/2" X 1 5/8"  
 Solid brass



**1464-PB** polished brass  
**1464-AB** antique brass  
 Plate: 3 1/8" X 2 1/4"  
 Solid brass



**1492-PB**  
 2 3/4" X 1 7/8"  
 Solid brass  
*Openwork keyhole plate*



**1491-PB**  
 3/4" X 2 5/8"  
 Solid brass  
*Openwork keyhole plate*

Chippendale style willow brasses  
 Keyhole plates (escutcheons)

Front view

Side view



**1199-PB**  
9/16" inside height  
Stamped brass

Front view

Side view



**1200-PL** lacquered polished brass  
Face: 1/2" X 7/8"  
Inside height: 11/16"  
Insert fits into 3/8" X 3/4" hole  
Solid brass  
Thread escutcheon  
With 2 brass pins



**1215-PB**  
3/4" outside height  
5/8" inside height  
Solid brass  
Thread escutcheon

3 keyhole inserts and thread escutcheons



**1287-PB** polished brass  
**1287-AB** antique brass  
2 1/8" wide , 5/8" projection  
1 5/8" center to center  
Solid brass  
Installed with screws  
Finger pull with a keyhole



**1288-PB** polished brass  
**1288-AB** antique brass  
2 1/8" wide , 5/8" projection  
1 5/8" center to center  
Solid brass  
Installed with screws  
Finger pull without a keyhole



**1289-PB** polished brass  
**1289-AB** antique brass  
1 7/8" wide , 5/8" projection  
Solid brass  
Arts & Crafts, turn of the century  
finger pull with a keyhole

3 finger pulls for drawers and china cabinet doors



Has "key" hole in top area

**1701-K-PL**  
6 3/4" high  
7/8" wide  
Solid brass  
Lacquered

Plate is same size as 1704



Large



**1704-PL** lacquered brass  
**1704-AB** antique brass  
Plate: 7/8" wide , 6 3/4" high  
Key bow: 1 1/8" wide  
1 1/16" projection  
Solid brass

**1707-PB** polished brass  
**1707-AB** antique brass  
Bow: 1 1/8" wide  
Projection: 1"  
Solid brass  
Key knob for cabinet doors



Cabinet door pulls

**1285-PB** polished brass  
**1285-AB** antique brass  
3 3/4" tall  
3/4" wide  
Cast brass  
Small pull with a keyhole  
For wardrobes, china cabinets etc.



Small

**1705-PL** lacquered brass  
**1705-AB** antique brass  
Plate: 3/4" wide , 5 1/4" high  
Key bow: 1 1/8" wide  
1 1/16" projection  
Solid brass



**1027-AC**  
 Plate: 1 1/2" X 4"  
 Forged brass  
 Antique copper finish  
 Hammered surface  
 Cabinet door pull with keyhole  
 With round-head slotted screws

Gustav Stickley cabinet door pulls with keyholes



**1029-AC**  
 Plate: 1 3/8" X 4"  
 Forged brass  
 Antique copper finish  
 Hammered surface  
 Cabinet door pull with keyhole  
 With round-head slotted screws



**1112-PB** polished brass  
**1112-AB** antique brass  
**1112-AC** antique copper  
**1112-BK** black  
 Plate: 1 1/4" X 3 3/4"  
 Cast brass  
 Hammered look  
 L. & J.G. Stickley cabinet door pull  
 Includes diamond-head screws



**1290-PB**  
 Knob 1 1/8" dia. , 3/4" projection  
 Oval base: 1 1/2" X 11/16"  
 Stamped brass with steel parts  
 Push catch with knob  
 For door thickness 1/4" to 7/8"



**1283-PB**  
 Base of knob: 1 3/16" X 1 5/16"  
 Projection: 13/16"  
 Solid brass with steel parts  
 Push catch with knob  
 For door thickness 1/4" to 3/4"

**3 Cabinet door pulls with push button catches**  
 Spring action push button can be adjusted for different widths of door  
 Catch and strike orientation can be set to right, left, up or down



**1284 -PB**  
 Handle: 3 3/8" high , 3/4" wide  
 Projection: 3/4"  
 Solid brass with steel parts  
 Push catch with Handle  
 For door thickness 1/2" to 1"

*Small*



**1612-PB** polished brass  
**1612-AB** antique brass  
**1612-OB** oil rubbed bronze  
**1612-PN** polished nickel  
**1612-BN** brushed nickel  
**1612-PC** polished chrome  
**1612-BC** brushed chrome  
 Latch: 1 1/8" X 1 3/4"  
 Catch: 1/2" X 1 3/4"  
*Solid brass*

Top quality solid brass die cast latches  
 For cabinet doors

*Large*

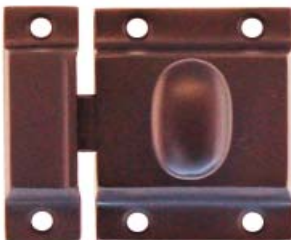

**1619-PB** polished brass  
**1619-OB** oil rubbed bronze  
**1619-PN** polished nickel  
**1619-BN** brushed nickel  
 Latch: 1 5/8" X 2 1/8"  
 Catch: 5/8" X 2 1/8"  
*Solid brass*

*Small*



**1617-PB** polished brass  
**1617-AB** antique brass  
**1617-AC** antique copper  
**1617-PN** polished nickel  
**1617-OB** oil rubbed bronze  
 Latch: 1 1/4" X 1 7/8"  
 Catch: 5/8" X 1 7/8"  
 Stamped steel

Utility latches for "Country" furniture

*Large*



**1618-PB** polished brass  
**1618-AB** antique brass  
**1618-AC** antique copper  
**1618-PN** polished nickel  
**1618-OB** oil rubbed bronze  
 Latch: 1 1/2" X 2 1/8"  
 Catch: 5/8" X 2 1/8"  
 Stamped steel

Ornate Victorian brass latches

*Small*



**1610-PB** polished brass  
**1610-AB** antique brass  
 Latch: 1 3/4" X 1 1/4"  
 Catch: 1" X 1 1/4"  
*Ornate cast brass*

*Large*



**1613-PB** polished brass  
**1613-AB** antique brass  
 Latch: 2 1/8" X 1 3/8"  
 Catch: 1 5/16" X 1 3/8"  
*Ornate cast brass*



Good Hardware  
at Good Prices



**6700-PN**  
Base 1 1/8" wide  
Stamped steel  
Nickel plated  
*Elbow Catch*



**1614-PB**  
2" base dia.  
Solid brass  
Polished brass finish  
*Table catch or turn button*

*When installing, gap between the 2 parts of base to be no more than 3/32"*



**1616-PB** polished brass  
**1616-AB** antique brass  
1 1/2" base dia.  
Solid brass  
*Turn button with back plates for cabinet doors*

For doors, cabinet doors, screens, windows etc.



**1615-BK**  
2" long  
Cast iron. Raised.  
Painted black (*japanned*)  
*Utility turn buttons*  
*Sold in pairs*

*Sold in pairs*



*Smaller knob*

**1253-PB**  
1" knob dia.  
*Cupboard turn*



*Larger knob*

**1254-PB**  
1 1/4" knob dia.  
*Cupboard turn*



*Tightly wedged through hole, post turns with knob to open or close cabinet door*

**1274-PB**  
1 3/8" dia.  
1 1/4" projection  
Ebonized wood and brass  
*Cupboard turn*



*End turn can be used with any knob from the catalog*

**1252-PB** End Turn  
Solid brass stop is 1 3/8" X 1/2"  
Stud is 8-32 X 2 3/4" long  
Brass plated threaded stud

3" CC

*Small*

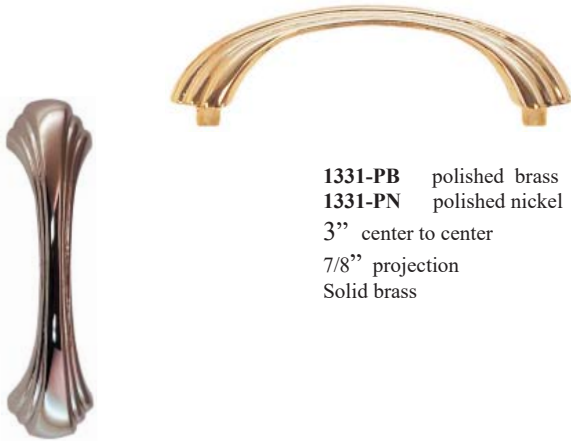

**1331-PB** polished brass  
**1331-PN** polished nickel  
 3" center to center  
 7/8" projection  
 Solid brass

Moderne pull in 3 sizes - can be used for drawers (horizontal) or for cabinet doors (vertical)

4" CC

*Medium*



**1333-PB** polished brass  
**1333-PN** polished nickel  
 4" center to center  
 7/8" projection  
 Solid brass

4 1/2" CC

*Large*



**1334-PB** polished brass  
**1334-PN** polished nickel  
 4 1/2" center to center  
 7/8" projection  
 Solid brass



4" CC

**1335-PB** polished brass  
**1335-PN** polished nickel  
 4" center to center  
 5" tall, 7/8" wide  
 7/8" projection  
 Solid brass  
*For cabinet doors (vertical)  
 and for drawers (horizontal)*



Art Deco hardware in two finishes:  
 polished nickel and polished brass

3 1/2" CC



**1332-PB** polished brass  
**1332-PN** polished nickel  
 3 1/2" center to center  
 7/8" projection  
 Solid brass

1 1/2" CC



**1330-PB** polished brass  
**1330-PN** polished nickel  
 1 1/2" center to center  
 7/8" projection  
 Solid brass



1 1/2" CC



**1330-PB** polished brass  
**1330-PN** polished nickel  
 1 1/2" center to center  
 7/8" projection  
 Solid brass



**1336-PB** polished brass  
**1336-PN** polished nickel  
 1 1/4" X 7/8"  
 7/8" projection  
 Solid brass



*Oblong octagonal knob*



**1337-PB** polished brass  
**1337-PN** polished nickel  
 1 3/16" dia.  
 1 1/8" projection  
 Solid brass



*Round knob with rings*

Visit our website at  
[www.timelyhardware.com](http://www.timelyhardware.com)  
 to see all products in all colors  
 and all finishes

*Art Deco hook*



**1906-PB** polished brass  
**1906-PN** polished nickel  
 Height: 2 1/2"  
 2 3/8" projection  
 Base: 1" X 1 5/8"  
 Solid brass

*Flush mount*



**1580-PB** polished brass  
**1580-BN** brushed nickel  
**1580-PN** polished nickel  
**1580-OB** oil rubbed bronze  
 2 1/4" X 1 1/2"  
 Solid brass  
*Flush mounting*

*Art Deco cabinet hinges*

*Offset*



**1581-PB** polished brass  
**1581-BN** brushed nickel  
**1581-PN** polished nickel  
**1581-OB** oil rubbed bronze  
 2 1/4" X 1 1/2"  
 3/8" offset  
 Solid brass



*Small*

- 1428-PB** polished brass
- 1428-PL** lacquered brass
- 1428-PN** polished nickel
- 1428-BN** brushed nickel
- 1428-OB** oil rubbed bronze
- 3 3/16" overall length
- 3" center to center
- Forged brass



*Large*

- 1429-PB** polished brass
- 1429-PL** lacquered brass
- 1429-PN** polished nickel
- 1429-BN** brushed nickel
- 1429-OB** oil rubbed bronze
- 4 1/2" overall length
- 4" center to center
- Forged brass



*Small*

- 1432-PB** polished brass
- 1432-PL** lacquered brass
- 1432-PN** polished nickel
- 1432-BN** brushed nickel
- 1432-OB** oil rubbed bronze
- 1" dia.
- 1" projection



*Large*

- 1433-PB** polished brass
- 1433-PL** lacquered brass
- 1433-PN** polished nickel
- 1433-BN** brushed nickel
- 1433-OB** oil rubbed bronze
- 1 1/4" dia.
- 1" projection



- 1434-PB** polished brass
- 1434-PL** lacquered brass
- 1434-PN** polished nickel
- 1434-BN** brushed nickel
- 1434-OB** oil rubbed bronze
- 1 1/4" dia.
- 1" projection

*Small*



- 1435-PB** polished brass
- 1435-PL** lacquered brass
- 1435-PN** polished nickel
- 1435-BN** brushed nickel
- 1435-OB** oil rubbed bronze
- 1" dia.
- 1 1/16" projection

*Large*



- 1436-PB** polished brass
- 1436-PL** lacquered brass
- 1436-PN** polished nickel
- 1436-BN** brushed nickel
- 1436-OB** oil rubbed bronze
- 1 1/4" dia.
- 1 3/16" projection

### Contemporary knobs & pulls

Classic elegance  
Solid brass - In 5 finishes

*Small*



- 1438-PB** polished brass
- 1438-PL** lacquered brass
- 1438-PN** polished nickel
- 1438-BN** brushed nickel
- 1438-OB** oil rubbed bronze
- 1" dia.
- 1 1/8" projection

*Large*



- 1439-PB** polished brass
- 1439-PL** lacquered brass
- 1439-PN** polished nickel
- 1439-BN** brushed nickel
- 1439-OB** oil rubbed bronze
- 1 1/4" dia.
- 1 3/16" projection



- 1437-PB** polished brass
- 1437-PL** lacquered brass
- 1437-PN** polished nickel
- 1437-BN** brushed nickel
- 1437-OB** oil rubbed bronze
- 1 3/4" wide
- 1 3/8" projection



Med.



- 1425-PB** polished brass
- 1425-PL** lacquered brass
- 1425-PN** polished nickel
- 1425-BN** brushed nickel
- 1425-OB** oil rubbed bronze
- 4 3/4" overall length
- 3" center to center

Large



- 1426-PB** polished brass
- 1426-PL** lacquered brass
- 1426-PN** polished nickel
- 1426-BN** brushed nickel
- 1426-OB** oil rubbed bronze
- 6 3/4" overall length
- 5" center to center
- Appliance pull*

Extra Large



- 1424-PB** polished brass
- 1424-PN** polished nickel
- 1424-BN** brushed nickel
- 1424-OB** oil rubbed bronze
- 8 7/8" overall length
- 7" center to center
- Appliance pull*

3 sizes: 3", 5", 7" center to center



Contemporary pulls

Classic elegance  
Solid brass - In 5 finishes  
For drawers and cabinet doors



- 1427-PB** polished brass
- 1427-PL** lacquered brass
- 1427-PN** polished nickel
- 1427-BN** brushed nickel
- 1427-OB** oil rubbed bronze
- 5 1/2" overall length
- 3 3/4" center to center



**1016-AC** antique copper  
 Plate: 3 3/4" X 2"  
 Forged brass  
 Antique copper finish  
 Hammered surface  
 Includes pyramid screws



**1015-AC** antique copper  
 Plate: 3 3/8" X 1 13/16"  
 Forged brass  
 Antique copper finish  
 Hammered surface  
 with oval ring  
 Includes pyramid screws



**1018-AC** antique copper  
 Plate: 2 3/4" X 1 3/8"  
 Forged brass  
 Antique copper finish  
 Hammered surface  
 Includes round-head slotted screws

Gustav Stickley drawer pulls



**1111-PB** polished brass  
**1111-AB** antique brass  
**1111-AC** antique copper  
**1111-BK** black  
 Plate: 3 1/8" X 1 1/2"  
 Cast brass  
 Hammered surface  
 L. & J.G. Stickley drawer pull  
 Includes diamond-head screws



**1112-PB** polished brass  
**1112-AB** antique brass  
**1112-AC** antique copper  
**1112-BK** black  
 Plate: 1 1/4" X 3 3/4"  
 Cast brass  
 Hammered surface  
 L. & J.G. Stickley cabinet door pull  
 Includes diamond-head screws

L & J G Stickley pulls

Without keyhole

With keyhole



**1017-AC** antique copper  
 Plate: 1 1/2" X 4"  
 Forged brass  
 Antique copper finish  
 Hammered surface  
 Includes pyramid screws

**1027-AC** antique copper  
 Plate: 1 1/2" X 4"  
 Forged brass  
 Antique copper finish  
 Hammered surface  
 Includes round-head slotted screws

Gustav Stickley cabinet door pulls

Without keyhole

With keyhole



**1019-AC** antique copper  
 Plate: 1 3/8" X 4"  
 Forged brass  
 Antique copper finish  
 Hammered surface  
 Includes round-head slotted screws

**1029-AC** antique copper  
 Plate: 1 3/8" X 4"  
 Forged brass  
 Antique copper finish  
 Hammered surface  
 Includes round-head slotted screws



**3502-AC** antique copper  
**3502-PW** pewter  
 Plate: 1 3/4" X 3 1/2"  
 Zinc alloy die cast  
 Hammered surface  
 Single post  
 Cabinet door pull

*Sold without screws  
 (They take 8-32 thread screws)*



**3503-AC** antique copper  
**3503-PW** pewter  
**3503-BK** black  
 Plate: 3 1/2" X 1 3/4"  
 3" center to center  
 Zinc alloy die cast  
 Hammered surface  
 Drawer pull



**6016** antique brass  
**6026** pewter  
**6036** flat black  
**6046** distressed black  
 1" X 3 3/4"  
 2 vertical posts with 2 1/4" CC  
 Zinc alloy die cast  
 Cabinet door pull

*Smaller*



**6017** antique brass  
**6027** pewter  
**6037** flat black  
**6047** distressed black  
 2 3/4" X 1 3/4"  
 1-1/8" vertical CC  
 Zinc alloy die cast  
 Drawer pull

*Larger*



**6018** antique brass  
**6028** pewter  
**6038** flat black  
**6048** distressed black  
 3 3/4" X 2"  
 3" center to center  
 Zinc alloy die cast  
 Drawer pull



**1265-PB**  
 Plate: 2 1/4" X 1 1/4"  
 1 1/4" ring dia.  
 Solid brass  
 Drawer Pull



**1264-PB**  
 Plate: 1" X 3 1/2"  
 1 1/4" ring dia.  
 Solid brass  
 Cabinet Door Pull  
 with keyhole



**1289-PB**  
 1 7/8" wide  
 5/8" projection  
 Solid brass  
 Finger Pull  
 with keyhole

### Arts & Crafts style pulls and keyhole covers



**1214-PB**  
 1 15/16" X 7/8"  
 Thick stamped brass  
 Diamond-shaped keyhole plate



**1216-PB**  
 1 15/16" X 7/8"  
 Thick stamped brass  
 Rectangular keyhole plate



**1023-AC**  
 1 5/8" X 1"  
 Forged brass  
 Antique copper finish  
 Rectangular keyhole plate



LARGE BRASS HANDLES IN THE ARTS & CRAFTS STYLE  
 Classic elegance for the home  
 3 sizes - 5 finishes  
 Great-looking and sturdy  
 Appliance pulls  
 For drawers, cabinet doors



4" center



- 3201-PB** polished brass
- 3201-AB** antique brass
- 3201-PN** polished nickel
- 3201-BN** brushed nickel
- 3201-OB** oil rubbed bronze

Center to center: 4"  
 Overall length: 4 7/8"  
 Width of handle: 3/8" X 3/8"  
 Projection: 1 1/4", clearance: 7/8"  
 Bases: 7/8" X 7/8"  
 Solid brass

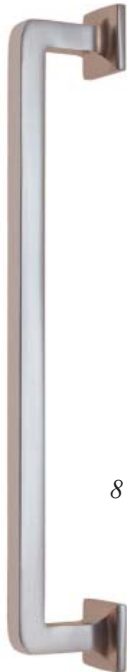

8" center



Large handle

- 3203-PB** polished brass
- 3203-AB** antique brass
- 3203-PN** polished nickel
- 3203-BN** brushed nickel
- 3203-OB** oil rubbed bronze

Center to center: 8"  
 Overall length: 8 7/8"  
 Width: 3/8" X 3/8"  
 Projection: 1 3/8", clearance: 1"  
 Bases: 7/8" X 7/8"  
 Solid brass



12" center



Extra large handle

- 3205-PB** polished brass
- 3205-AB** antique brass
- 3205-PN** polished nickel
- 3205-BN** brushed nickel
- 3205-OB** oil rubbed bronze

Center to center: 12"  
 Overall length: 12 7/8"  
 Width: 3/8" X 3/8"  
 Projection: 1 3/8", clearance: 1"  
 Bases: 7/8" X 7/8"  
 Solid brass



**1147-PB** polished brass  
**1147-PN** polished nickel  
 2" center to center  
 Solid brass  
*Little pull for small drawers, cubbyholes, etc.*



**1113-PB** polished brass  
**1113-BN** brushed nickel  
**1113-PN** polished nickel  
**1113-OB** oil rubbed bronze  
 3" center to center  
 Solid brass



*Can be used horizontally for drawers or vertically for cabinet doors*

Solid brass "square" handles



**1148-PB** polished brass  
**1148-BN** brushed nickel  
**1148-PN** polished nickel  
**1148-OB** oil rubbed bronze  
 3 1/2" center to center  
 Solid brass



**1114-PB** polished brass  
**1114-BN** brushed nickel  
**1114-PN** polished nickel  
**1114-OB** oil rubbed bronze  
 4" center to center  
 Solid brass



**1553-AC**  
 Leaf 2" high  
 Steel  
 Ant. copper finish  
*With ball tips*

Smaller



**1556-AC**  
 Leaf 2" high  
 Steel  
 Ant. copper finish  
*With steeple tips*

Non-mortise hinges  
 Sold in pairs



**1554-AC**  
 Leaf 2 1/2" high  
 Steel  
 Ant. copper finish  
*With ball tips*

Larger



**1557-AC**  
 Leaf 2 1/2" high  
 Steel  
 Ant. copper finish  
*With steeple tips*



**1020-AC** antique copper finish  
 1 3/16" X 1 3/16"  
 Base: 13/16" X 13/16"  
 15/16" projection  
 Forged brass  
 Antique copper finish  
 Hammered surface  
*Pyramid Knob*



*Small*

**1261-PB** polished brass  
 3/4" square  
 3/4" projection  
 Solid brass  
*Pyramid Knob*



**1266-PB** polished brass  
 3/4" X 3/4"  
 Heavy stamped brass  
*Square back plate*  
*For use with knob #1261*  
*or just as a square plate*



*Medium*

**1262-PB** polished brass  
**1262-BN** brushed nickel  
**1262-PN** polished nickel  
**1262-OB** oil rubbed bronze  
 1" square  
 7/8" projection  
 Solid brass  
*Pyramid Knob*



*Large*

**1263-PB** polished brass  
**1263-BN** brushed nickel  
**1263-PN** polished nickel  
**1263-OB** oil rubbed bronze  
 1 1/4" square  
 1" projection  
 Solid brass  
*Pyramid Knob*

*Small*



**4200**  
 3/4" square  
 13/16" project.  
 Oak

*Medium*



**4201** oak  
**4201-BK** black  
**4201-C** cherry  
**4201-WI** walnut  
 1 1/4" square  
 7/8" projection  
 Oak and other woods

*Large*



**4203**  
 1 3/4" square  
 1 1/8" projection  
 Oak

Oak pyramid knobs and handle



**4205**  
 3" center to center  
 4 1/2" X 1 3/8"  
 1 1/8" projection  
 Oak



9908

Base: 1 3/4" X 3 1/4"  
 4" projection  
 Iron  
 Painted dark brown/black  
 3-pronged Gustav Stickley  
 hall tree hook

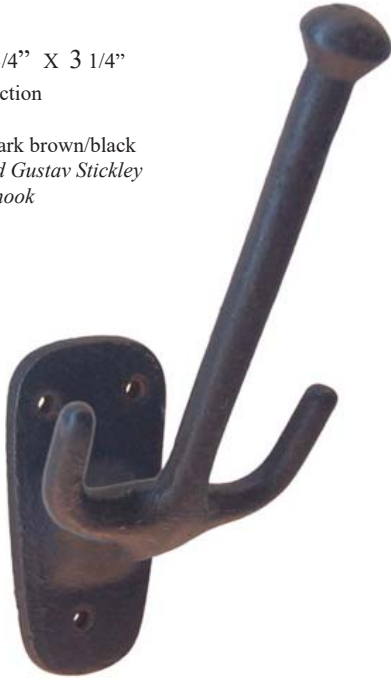

9907

5 1/2" tall  
 3 1/2" projection  
 Base: 1 1/16" X 2"  
 Cast iron, black

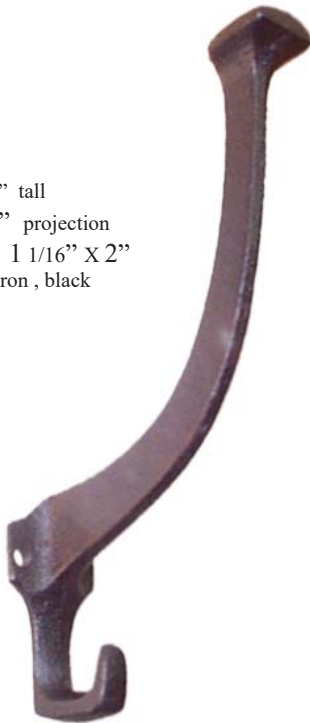

1362

For 1/2" square screw head  
 Steel, painted black  
 Wrench for #1014-AC  
 pyramid screws  
 shown on right



**1902-PB** polished brass  
**1902-BN** brushed nickel  
**1902-PN** polished nickel  
**1902-OB** oil rubbed bronze  
 5 1/2" tall  
 3 1/4" projection  
 Base: 9/16" X 2 1/4"  
 Solid brass



Round head

**1009-PB** polished brass  
**1009-PN** polished nickel  
**1009-AB** antique brass  
**1009-OB** oil rubbed bronze  
 #5 X 5/8" round-head slotted brass wood screw  
 Sold in bags of 20



**1012-AC** Antique copper finish  
 #8 X 1/2" long  
 Round-head slotted steel wood screw  
 Sold in bags of 20

Screws for Mission / Arts & Crafts hardware



**1013-AC** Antique copper finish  
 Head: 5/16" X 5/16"  
 3/4" long stem  
 Iron  
 Square-head screw - Sold each



**1014-AC** Antique copper finish  
 Head: 1/2" X 1/2"  
 1/2" long stem  
 Iron  
 Pyramid screw - Sold each



**1014-AC** antique copper  
Head: 1/2" X 1/2"  
Threaded part: 1/2" long  
Iron, antique copper finish  
*Pyramid Screws*



**1013-AC** antique copper  
Head: 5/16" X 5/16"  
Threaded part: 3/4" long  
Iron, antique copper finish  
*Square head Screws*



**1012-AC** antique copper  
1/2" long  
Round head slotted steel screws  
Antique copper finish  
*Sold in bags of 20*

Screws for Mission / Arts & Crafts hardware



**1178-PB** polished brass  
**1178-AB** antique brass  
Stem 1 1/8" long  
Steel eyelets & nuts  
*Standard eyelet posts for drop handles. Sold in pairs*



**1187-PB** polished brass  
**1187-AB** antique brass  
7/8" projection  
Solid brass  
*Ornate posts for Victorian pulls can be used with any back plate or drop handle in the catalog Sold in pairs*



**1188-PB** polished brass  
**1188-PN** polished nickel  
5/8" projection  
Solid brass  
*Square posts for Victorian Eastlake pulls Sold in pairs*



**1198-PB**  
3/4" projection  
Shanks tapped for 8-32 thread  
Solid brass  
*Fit all drawer pulls on pages 49-51. Posts hold handle 3/4" in front of plate for easier grasp. Screws included. Sold in pairs*

Eyelets and posts



**1007-PB** polished brass  
**1007-PN** polished nickel  
**1007-AB** antique brass  
**1007-OB** oil rubbed bronze  
#7 X 1" flat-head slotted brass wood screws  
*Sold in bags of 20*



**1008-PB** polished brass  
**1008-PN** polished nickel  
**1008-AB** antique brass  
**1008-OB** oil rubbed bronze  
#7 X 1" flat head Phillips brass wood screws  
*Sold in bags of 20*



**1006-PB** polished brass  
**1006-PN** polished nickel  
**1006-AB** antique brass  
**1006-OB** oil rubbed bronze  
#5 X 5/8" flat head slotted brass wood screws  
*Sold in bags of 20*



**1009-PB** polished brass  
**1009-PN** polished nickel  
**1009-AB** antique brass  
**1009-OB** oil rubbed bronze  
#5 X 5/8" round head slotted brass wood screws  
*Sold in bags of 20*



**1010-PB** polished brass  
**1010-AB** antique brass  
**1010-PN** polished nickel  
**1010-OB** oil rubbed bronze  
#5 X 5/8" oval head slotted brass wood screws  
*Sold in bags of 20*



**1011-PB**  
8-32 thread  
1 1/8" long  
Steel, brass plated  
*Studs and nuts Sold in pairs*



Finishing Washers

**1179-PB** polished brass  
**1179-AB** antique brass  
15/16" dia.  
Stamped brass  
*Standard back plate for knobs and bail sets - sold in pairs*



**1189-PB** polished brass  
**1189-AB** antique brass  
1 1/8" dia.  
Stamped brass  
*"Fancy" back plate for bail sets, ornate knobs, etc. - sold in pairs*



- 5291-PN** nickel plated 2 1/2" long
  - 5292-PB** brass plated 2 1/2" long
  - 5293-PN** nickel plated 3" long
  - 5294-PB** brass plated 3" long
- Steel bolt & nut  
Bolts for Glass Knobs & Handles

Authentic pan-head screws for glass knobs and glass handles come with square nuts. The heads of the screws are smooth. The upper part of the stem is threadless for better appearance.



- 5296-PN-1.00** nickel plated
  - 5296-PN-1.25** nickel plated
  - 5296-PN-1.50** nickel plated
  - 5296-PB-1.00** brass plated
  - 5296-PB-1.25** brass plated
  - 5296-PB-1.50** brass plated
- Post: 7/32" dia. , 7/8" long  
Screw length: 1" or 1.25" or 1.50"  
Steel post and screw

Posts & Screws: an alternative way to install glass knobs and handles. There are 3 lengths of screws corresponding to the sizes of the knobs. Please specify size when ordering (for handles order 1.25" screws).

Website: [www.timelyhardware.com](http://www.timelyhardware.com)



- 1361**  
Overall length 6 1/8"  
3/8" dia., Shank 5 3/8" long  
Square head 1/2" X 1/2"  
Iron  
Bed bolt  
Includes a 3/4" square steel nut



- 1362**  
For 1/2" square screw head  
4" long handle  
3" long square tube  
Steel, painted black  
Bed Bolt Wrench for #1361 bed bolt shown below left

Also good for #1014 pyramid screws, shown on next page



Larger

- 1357-PB** polished brass
  - 1357-AB** antique brass
- 2" dia.  
2 1/2" high  
3/8" thread dia. , 16 TPI  
Solid brass

Brass bed finials in 2 sizes



Smaller

- 1358-PB** polished brass
  - 1358-AB** antique brass
- 1 3/4" dia.  
2 1/4" high  
3/8" thread dia. , 16 TPI  
Solid brass

Bed hardware and accessories



- 1359-PB** polished brass
  - 1359-AB** antique brass
- 1 3/4" dia. , 1/2" high  
Stamped brass  
Bed finial washer goes under the bed finials shown above



- 1360-PB** polished brass
  - 1360-AB** antique brass
- 1 5/8" dia. ,  
Cast brass  
Bed Bolt Cover  
Available in 2 finishes

Standard latch



**1605-PB** polished brass  
**1605-PN** polished nickel  
 Housing: 1 1/8" X 2 1/4"  
 Includes centered catches  
 For right- or left-hand doors

"H" latch



**1597-PB** polished brass  
**1597-PN** polished nickel  
 Housing: 1 1/8" X 2 1/4"  
 Includes centered catches  
 For right- or left-hand doors

Oval latch



**1607-PB** polished brass  
**1607-PN** polished nickel  
 Housing: 1" X 2"  
 Includes centered catches  
 For right- or left-hand doors

Each latch comes with 1 flush strike and 1 offset strike as shown.  
 Catches are centered for use with both right and left doors.

All solid brass



Flush mount

3/8" offset mount

**1623-PB** Flush polished brass  
**1623-PN** Flush polished nickel  
**1624-PB** Offset polished brass  
**1624-PN** Offset polished nickel  
 Base: 5/16" X 1 1/2"  
 Centered catches for Hoosier latches  
 Enable use with either Right Hand or Left Hand door.

Hoosier cabinet strikes

Flush mount



**1621-PB** polished brass  
 1/2" base dia.  
 "Bullet" catch for Hoosier latches  
 For use with either L.H. or R.H. door  
 Can be used with any of the latches above

Ring latches



**1604-PB** polished brass  
**1604-PN** polished nickel  
 Housing: 1 1/4" X 2"  
 Left Hand



**1603-PB** polished brass  
**1603-PN** polished nickel  
 Housing: 1 1/4" X 2"  
 Right Hand

"S" latches



**1595-PB** polished brass  
**1595-PN** polished nickel  
 Housing: 1 1/8" X 2 1/4"  
 Left Hand



**1596-PB** polished brass  
**1596-PN** polished nickel  
 Housing: 1 1/8" X 2 1/4"  
 Right Hand

All solid brass



Lever latches  
 Flush mount

Base dia.: 1 9/16"



**1641-PB** polished brass  
**1641-PN** polished nickel  
 Left Hand

**1642-PB** polished brass  
**1642-PN** polished nickel  
 Right Hand



Lever latches  
 3/8" Offset mount

Base dia.: 1 9/16"



**1643-PB** polished brass  
**1643-PN** polished nickel  
 Left Hand

**1644-PB** polished brass  
**1644-PN** polished nickel  
 Right Hand

Offset depends on which leaf is on frame and which on door



**1626-PB** polished brass  
**1626-PN** polished nickel  
 3 1/4" X 1 1/2"  
 2 offsets: 3/8" & 1/2"  
 Solid brass  
*Wraparound hinge*



**1627-PB** polished brass  
**1627-PN** polished nickel  
 2" X 2"  
 3/8" offset  
 Solid brass  
*Reversed pad*



**1628-PB** polished brass  
**1628-PN** polished nickel  
 2" X 1 1/2"  
 3/8" offset  
 Solid brass

All solid brass



**1591-PB** polished brass  
**1591-PN** polished nickel  
 2" X 1 3/4"  
 3/8" offset  
*Reversed pad*



**1592-PB** polished brass  
**1592-PN** polished nickel  
 1 7/8" X 1 3/4"  
 3/8" offset



**1600-PB** polished brass  
**1600-PN** polished nickel  
 2 1/4" X 1 5/8"  
 3/8" offset



**1594-PB** polished brass  
**1594-PN** polished nickel  
 2 1/2" X 1 1/2"  
 3/8" offset



**1593-PB** polished brass  
**1593-PN** polished nickel  
 1 3/4" X 1 1/4"  
 3/8" offset  
*Scalloped*

All solid brass



**1599-PB** polished brass  
**1599-PN** polished nickel  
 2 3/8" X 1 1/2"  
 3/8" offset  
*Reversed pad*

Small



**1601-PB** polished brass  
**1601-PN** polished nickel  
 1 5/8" X 1 1/2"  
 3/8" offset

Large



**1602-PB** polished brass  
**1602-PN** polished nickel  
 1 3/4" X 2"  
 3/8" offset





For "Sellers" cabinets  
and other brands

**6601**  
11" long, 2 1/4" high  
Side clearance: 3/8"  
Heavy gauge steel



For "Hoosier" cabinets  
and other brands

**6602**  
10 1/2" X 4 1/2"  
Side clearance: 1/4"  
Heavy gauge steel

### Side brackets for Hoosier kitchen cabinets

Brackets used to mount upper unit onto base of cabinet, making room for work-top to slide in between.  
Side clearance is the distance a work-top can exceed the cabinet's side.  
*While typical of some brands, brackets can be used on many others.*



For "Boone", "McDougall"  
and other cabinet brands

**6603**  
10 3/4" long, 2 3/4" high  
Side clearance: 3/4"  
Heavy gauge steel

Sold in complementary  
pairs: left- & right-hand



For "Hoosier" cabinets  
and other brands

**6604**  
10 5/8" X 3 3/4"  
Side clearance: 3/4"  
Heavy gauge steel  
*Sold in pairs*



For "Wilson" cabinets  
and other brands



**6605**  
11" long, 2 3/16" high  
Side clearance: 1 3/8"  
Heavy gauge steel  
*Larger bracket for use on cabinets  
with wider porcelain work top*

*Premium Hoosier bin pull*



**1163-PB** polished brass  
**1163-PN** polished nickel  
 3" center to center  
 3 1/2" wide  
 Heavy-stamped brass



**1160-PB** polished brass  
**1160-PN** polished nickel  
 3" center to center  
 3 1/2" wide  
 Stamped brass  
*With beveled edges*

*Larger*



**1130-PB** polished brass  
**1130-PN** polished nickel  
 3" center to center  
 3 5/8" X 3/4"  
 Cast brass

*Smaller*



**1131-PB** polished brass  
**1131-PN** polished nickel  
 2 3/8" center to center  
 3" long, 5/8" projection  
 Cast brass



**1162-PB** polished brass  
**1162-PN** polished nickel  
 2 7/8" center to center  
 3 1/2" wide, 1" high  
 Stamped brass



**1159-PB** polished brass  
**1159-PN** polished nickel  
 2 3/4" center to center  
 3 1/4" wide, 5/8" high  
 Heavy stamped brass



**1385-PB** polished brass  
**1385-PN** polished nickel  
 1 1/4" X 1 1/4"  
 Stamped brass  
*Hoosier cabinet leg skirt*



*Fits snugly at base of cabinet leg as shown above*



*1 1/4" dia.*

**5202** clear  
**5252** Depression green  
 1 1/4" dia.  
 Glass  
*Hexagonal glass knob*  
*With 2-1/2" long bolt*



**5297** Hex Glass Knob  
 1 1/4" dia.  
 Glass shank 1/2" dia.  
 Clear glass  
*Includes brass sleeve*



**5297-F** Sleeve for Glass Knob  
 5/8" long, 1/2" dia.  
 Stamped brass  
*Used to install glass knob above*  
*Can be ordered separately*



**1245-PB** polished brass  
**1245-PN** polished nickel  
 1 1/8" dia.  
 3/4" high  
 Stamped brass



**9140**  
 4 1/4" wide  
 2 7/8" center to center  
 Cast iron, black



**9141**  
 3 3/8" wide  
 2 3/4" center to center  
 Cast iron, black

Drawer / bin pulls



**9138**  
 4" wide  
 3 1/4" center to center  
 Cast iron, black



**9139**  
 3 1/2" wide  
 2 15/16" center to center  
 Cast iron, black



**1143-BK**  
 3 3/4" wide  
 1 1/2" high  
 3 1/4" center to center  
 3/4" projection  
 Stamped steel, black



**9123** Handle  
 3" center to center  
 3 1/2" overall length  
 Cast iron, flat black  
*For drawers, cabinet doors,  
 screen doors etc.*



**9565** Hinge  
 2" X 2 3/8"  
 Steel, black  
*Flush mount  
 Butterfly hinge*





**9262**  
1" X 1"  
7/8" projection  
Cast iron , black  
*Mission / A & C style*  
*Pyramid Knob*

Knobs

*Small*



**9252**  
1 3/16" dia.  
1 3/16" projection  
Iron  
Painted black

*Large*



**9253**  
1 3/8" dia.  
1 3/8" projection  
Iron  
Painted black  
*A larger version of 9252, this knob is also used on many French style furniture pieces*



**9901** Hook  
4 1/2" high  
2 3/4" projection  
Base: 1 1/8" X 2 1/8"  
Cast iron , black  
*Hall tree hook*

*Art Nouveau style*

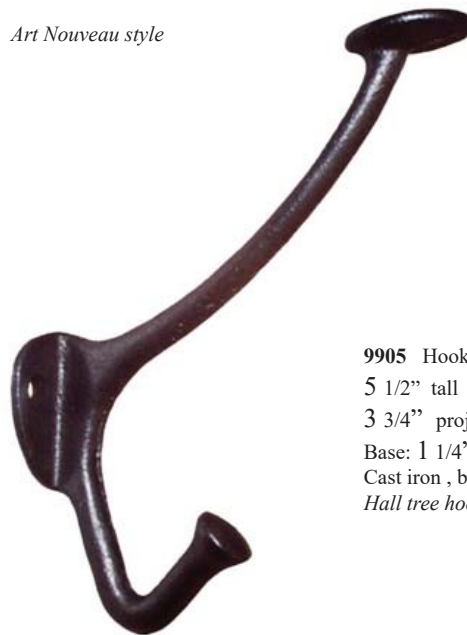

**9905** Hook  
5 1/2" tall  
3 3/4" projection  
Base: 1 1/4" X 1 3/8"  
Cast iron , black  
*Hall tree hook*



**9903** Hook  
3 1/2" high  
2 5/8" projection  
Base: 1 3/8" X 1"  
Cast iron, black  
3-pronged utility hook

*"Acorn" hooks*



*Gustav Stickley*  
3-pronged  
hall tree hook

**9908**  
Base: 1 3/4" X 3 1/4"  
4" projection  
Iron  
Painted dark brown/black  
*Arts & Crafts hook*

Cast iron hooks

*Arts & Crafts style*

*"Schoolhouse" hook*



**9904** Hook  
3" high  
3 1/8" projection  
Base: 1 3/4" X 2"  
Cast iron, black



**9907** Hook  
5 1/2" high  
3 1/2" projection  
Base: 1 1/16" X 2"  
Cast iron, black  
*Costumer hook*



**3310-AB** antique brass  
**3311-AC** antique copper  
 Height: 5"  
 3 1/2" projection  
 Base: 7/16" X 2 3/8"  
 Screws distance 1 13/16"  
 Zinc alloy die cast  
*Costumer hook*



**1903-PB**  
 Width: 5 1/4"  
 3" projection  
 1 1/4" collar dia.  
 Solid brass  
*Hall tree hook with 4 prongs*

*Installed from the back with a stud & nut*



**1902-PB** polished brass  
**1902-PN** polished nickel  
**1902-BN** brushed nickel  
**1902-OB** oil rubbed bronze  
 Height: 5 1/2"  
 3 1/4" projection  
 Base: 9/16" X 2 1/4"  
 Solid brass

*Arts & Crafts style*



*Art Nouveau style*

**1905-PB**  
 5 1/4" high  
 3 3/4" projection  
 Base: 1 3/8" X 1 1/2"  
 Solid brass



**1904-PB**  
 Height: 3"  
 3 3/4" projection  
 Base: 1 1/2" X 1 1/2"  
 Solid brass  
*Victorian "acorn" hook*



**1901-PB**  
 Height: 4 1/2"  
 3" projection  
 Base: 1 1/8" X 2 1/8"  
 Solid brass  
*Hall tree hook*



**1900-PB**  
 1 3/8" projection  
 Base: 3/4" X 1 1/2"  
 Solid brass  
 "Wardrobe" hook



**1908-PB** polished brass  
**1908-PN** polished nickel  
 1 5/8" projection  
 Base: 1 1/8" X 1 1/4"  
 Solid brass  
 Household hook

For hall, bathroom, kitchen, etc.



**1909-PB** polished brass  
**1909-PN** polished nickel  
 3 1/8" projection  
 Base: 1 3/4" X 1 3/4"  
 Solid brass  
 Household hook with 2 prongs



**1906-PB** polished brass  
**1906-PN** polished nickel  
 Height: 2 1/2"  
 2 3/8" projection  
 Base: 1" X 1 5/8"  
 Solid brass

Art Deco style

Bottle Opener



**1515-PB** polished brass  
**1515-BN** brushed nickel  
**1515-PN** polished nickel  
**1515-AB** antique brass  
 2 1/2" X 3"  
 Solid brass  
 For kitchens, ice boxes, etc.

For doors, gates, refrigerators etc.

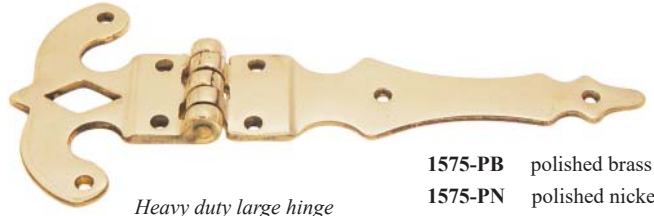

Heavy duty large hinge

**1575-PB** polished brass  
**1575-PN** polished nickel  
 11" long, 5" at widest  
 Solid brass  
 Cast, highly polished



**1500-PB** polished brass  
**1500-PL** lacquered brass  
**1500-PN** polished nickel  
**1500-AB** antique brass  
 3/8" offset  
 3 1/2" long, 1 7/8" wide  
 Solid brass



**1502-PB** polished brass  
**1502-PN** polished nickel  
 4 1/8" long, 1 5/8" wide  
 3/8" offset  
 Heavy gauge stamped brass

Ice Box or refrigerator hardware



Left Hand  
 ice box latch  
 and strike

**1506-PB** polished brass  
**1506-PL** lacquered brass  
**1506-PN** polished nickel  
**1506-AB** antique brass  
 3/8" offset  
 Base: 2 1/4" high  
 Lever: 3 1/4" long  
 Solid brass  
 For left hand door



Right Hand  
 ice box latch  
 and strike

**1505-PB** polished brass  
**1505-PL** lacquered brass  
**1505-PN** polished nickel  
**1505-AB** antique brass  
 3/8" offset  
 Base: 2 1/4" high  
 Lever: 3 1/4" long  
 Solid brass  
 For right hand door

Ice Box Name Plate



**1510-PB** polished brass  
**1510-PL** lacquered brass  
**1510-PN** polished nickel  
**1510-AB** antique brass  
 3 1/2" X 1 1/2"  
 Solid brass



**UPC BAR-CODE LABELS**

Would UPC bar-code labels on your products help you with your operation at your point of sale? We can put our UPC bar-code labels on products for you. Please contact us for more information.



**6100**  
5 1/2" wide  
3 1/2" center to center  
Zinc diecast & Bakelite



**6103**  
5 1/8" wide  
4 1/2" center to center  
Zinc diecast & Bakelite



**6101**  
6" wide  
4 1/4" center to center  
Zinc diecast & Bakelite

*Bakelite and die-cast metal pulls and knob  
for waterfall, Depression, 1930's furniture, etc.  
Metal parts in antique brass finish*



**6102**  
4 3/4" wide  
4" center to center  
Zinc diecast & Bakelite



**6104**  
2" dia.  
3/4" projection  
Zinc diecast & Bakelite

MORRIS CHAIR HARDWARE



- 1348-PB** polished brass
- 1348-AB** antique brass
- 1348-OB** oil rubbed bronze

26 1/4" long (between balls)  
 1" ball dia.  
 3/8" rod dia.  
 Brass balls and brass rod  
*Balls are attached with hex-drive set-screw so the length of the rod can be shortened as needed.*  
*Allen key included.*



Morris chair rod

Morris chair hardware  
 Authentic racks and rods for reclining armchairs



- 1349-PB** polished brass
- 1349-AB** antique brass
- 1349-OB** oil rubbed bronze

6 1/2" long (from tip to tip)  
 3/4" wide  
 Brass plated cast iron  
*Morris chair rack with slots for 4 leaning positions*

*Sold in pairs*

Morris chair racks  
 Sold in pairs

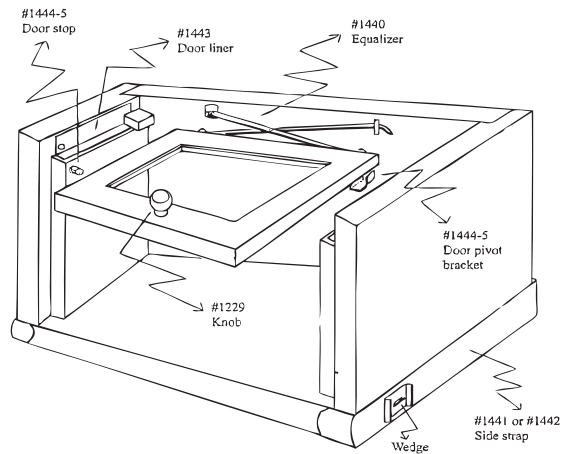

Lawyer/Barrister  
 Stacking Bookcase

Hardware usage plan

Hardware shown on next page



**1440-PS**  
 24" long , 7/16" wide  
 Polished steel  
*Bookcase Equalizer*  
 comes with fasteners as shown

**Hardware for stacking bookcases with retractable glass doors**

*All parts, with their fasteners, needed to restore a section  
 For Globe Wernicke or Macy's traditional lawyers' bookcases*

17-1/2" long

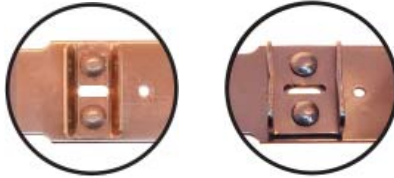

Small interlocking brackets attached to straps enable connecting bookcases side by side  
 The little wedges are installed in the slots



**1442-AB**  
 17 1/2" long , 1" wide  
 Steel, antique brass finish  
*Straps for the deepest bookcases made*  
 Steel wedges and brass nails for installation are included  
 Sold in pairs

**Bookcase Side Straps**

Straps, or bands, can be cut to size as needed

11-1/2" long



**1229-PB** polished brass  
**1229-PN** polished nickel  
 5/8" dia. , 9/16" high  
 Solid brass  
*Bookcase Knob*

*Other bookcase knobs shown on page 72*



**1441-AB**  
 11 1/2" long , 1" wide  
 Steel, antique brass finish  
*Most commonly used bookcase straps*  
 Steel wedges and brass nails for installation are included  
 Sold in pairs



**1445-AB**  
 Steel brackets with antique brass finish  
 Steel bushing with 1" long screw  
*Bookcase Door Stops and pivot brackets*  
 Sold in pairs (unit is as shown)

*Brackets installed on door, stops installed on frame.  
 When door is pulled out, brackets pivot on stops until door is horizontal and can be pushed inside bookcase section.*



*Liner for smoother door movement*

**1443-ZP**  
 10 1/2" long , 1" high , base 1/4"  
 Steel , zinc plated  
*Bookcase door liners*  
 L-shaped pieces can be cut to length  
 Sold in pairs



*Stem and plate casters*

**1373-PB** polished brass  
**1373-AB** antique brass  
**1373-PN** polished nickel  
 1 1/4" brass wheel  
 1 1/8" plate dia.  
 Brass horn and plate



**1371-PB** polished brass  
**1371-AB** antique brass  
**1371-PN** polished nickel  
 1" brass wheel  
 1 1/8" plate dia.  
 Brass horn and plate



*Stem casters*

**1370-PB** polished brass  
**1370-AB** antique brass  
 1" brass wheel  
 Brass horn



*Smallest brass caster*

**1369-PB** polished brass  
**1369-AB** antique brass  
 3/4" brass wheel  
 Brass horn  
*Stem caster*



*Round cup casters*

**1374-PB** polished brass  
**1374-AB** antique brass  
**1374-PN** polished nickel  
 1 1/4" brass wheel  
 1 1/4" top of socket inner dia.  
 Brass horn and socket



**1372-PB** polished brass  
**1372-AB** antique brass  
**1372-PN** polished nickel  
 1" brass wheel  
 1" top of socket inner dia.  
 Brass horn and socket

## Philadelphia pattern forged Solid brass casters

With 1 1/4" drive screw stems

### Deep socket casters



*Square cup casters*

**1389-PB** polished brass  
**1389-AB** antique brass  
**1389-PN** polished nickel  
 1 1/4" brass wheel  
 1 1/4" top of socket opening  
 Brass horn and socket



**1388-PB** polished brass  
**1388-AB** antique brass  
 1" brass wheel  
 1" top of socket opening  
 Brass horn and socket



*Porcelain Wheel*

**1366-PB**  
 1" porcelain wheel  
 Brass horn  
*Stem caster*



**1367-PB**  
 1" porcelain wheel  
 1 1/8" plate dia.  
 Brass horn and plate  
*Stem and plate caster*





**1381-PB** polished brass  
**1381-AB** antique brass  
**1381-PN** polished nickel  
 1" brass wheel  
 1 1/8" plate dia.  
 Brass horn and plate  
*Stem and plate caster*  
 English pattern

English pattern



**1384-PB** polished brass  
**1384-AB** antique brass  
 1 3/8" brass wheel  
 1 1/8" plate dia.  
 Brass horn and plate  
*Stem and plate caster*  
 English pattern



**1382-PB** polished brass  
**1382-AB** antique brass  
 3/4" brass wheel  
 7/8" plate dia.  
 Brass horn and plate

19th century plate casters with long pivots



**1383-PB** polished brass  
**1383-AB** antique brass  
 1" brass wheel  
 1 1/8" plate dia.  
 Brass horn and plate

Small



**1386-PB** polished brass  
**1386-AB** antique brass  
 15/16" inner dia.  
 Solid brass  
*Plain caster ring*



**1387-PB** polished brass  
**1387-AB** antique brass  
 1 3/16" inner dia.  
 Solid brass  
*Beaded caster ring*

Large

2 Round caster rings (shallow sockets) in 2 finishes

The ring sits over the caster's plate and surrounds the base of the furniture leg

#1382 caster shown with #1386 ring



#1371 caster shown with #1387 ring



**4901**  
 Base dia.: 2 1/2"  
 Opening dia.: 1 5/8"  
 Oak  
*Caster cup*

*Hardwood caster cup to protect the floor  
 For casters with a diameter of up to 2"*



Small

**1391**  
 1 1/4" wheel dia.  
 Steel assembly with  
 hardwood wheel  
 Includes 2 sockets  
*Sold in pairs*



Casters with hardwood wheels  
 Wheels with dark color

**1392**  
 1 1/4" wheel dia.  
 Steel assembly with  
 hardwood wheel  
 Includes 2 sockets  
*Ball bearing casters*  
*Sold in pairs*



Medium

**1393**  
 1 5/8" wheel dia.  
 Steel assembly with  
 hardwood wheel  
 Includes 2 sockets  
*Sold in pairs*



**1394**  
 1 5/8" wheel dia.  
 Steel assembly with  
 hardwood wheel  
 Includes 2 sockets  
*Ball bearing casters*  
*Sold in pairs*



Large

**1395**  
 2" wheel dia.  
 Steel assembly with  
 hardwood wheel  
 Includes 2 sockets  
*Sold in pairs*



**1396**  
 2" wheel dia.  
 Steel assembly with  
 hardwood wheel  
 Includes 2 sockets  
*Ball bearing casters*  
*Sold in pairs*

Grip-neck casters with steel horns and hardwood wheels  
 Steel stem 1" long, 5/16" in diameter

#1392, #1394 and #1396 have ball bearings for enhanced swiveling

Large

*Black  
 rubber  
 wheel*



**1398-BK**  
 2" wheel dia.  
 Steel assembly in  
 antique brass finish  
 Includes 1 socket  
*Ball bearing caster with  
 black rubber wheel*  
*Sold each*



*Grip Neck Sockets*

**1399-ZP**  
 1 1/8" tall  
 fit in a hole with 3/8" diameter  
 Steel, zinc plated  
*Extra sockets for all the casters above*  
*Sold in pairs*

Small



**1375-PB** polished brass  
**1375-AB** antique brass  
 7/8" wide  
 7/8" high  
 1 1/4" long  
 Stamped brass

Medium



**1376-PB** polished brass  
**1376-AB** antique brass  
 1 1/4" wide  
 1 1/4" high  
 2" long  
 Stamped brass

Large



**1377-PB** polished brass  
**1377-AB** antique brass  
 1 5/8" wide  
 1 1/2" high  
 2 3/4" long  
 Stamped brass

Duncan Phyfe lion claw foot toe caps

Medium



**1379-PL**  
 1 1/2" wide  
 1 1/2" high  
 2" long  
 Stamped brass  
 Lacquered brass  
 Plain toe cap

Large



**1380-PL**  
 1 3/4" wide  
 1 5/8" high  
 2 1/8" long  
 Stamped brass  
 Lacquered brass  
 Plain toe cap

Plain lacquered toe caps



**1385-PB** polished brass  
**1385-PN** polished nickel  
 1 1/4" X 1 1/4"  
 Stamped brass  
 Hoosier cabinet leg skirt



**1352-PB** brass plated  
 Pin is 2" long  
 Each bracket is 1/2" X 1 1/2"  
 Steel

**Mirror Mounting Friction Hinges**  
 Friction is adjusted by tightening the screws on the brackets  
 Sold in pairs



**1353-PB** brass plated  
**1353-OB** oil rubbed bronze  
 Pin is 2" long  
 Each bracket is 3/4" X 1 1/4"  
 Steel



Sold in pairs  
 as shown



Cheval mirror mounting hinge set

**1351-PB** polished brass  
**1351-AB** antique brass  
**1351-PL** lacquered polished brass  
 1 1/4" ring dia.  
 2 threaded studs are provided:  
 2 1/4" long & 3 1/2" long  
 Solid brass parts with brass plated studs



**1401-PB** polished brass  
**1401-PN** polished nickel  
**1401-BN** brushed nickel  
**1401-OB** oil rubbed bronze  
 Frame: 2 7/8" X 1"  
 Card size: 2 1/2" X 1 5/16"  
 Stamped brass  
*Label holder pull*



**1402-PB** polished brass  
**1402-AB** antique brass  
**1402-PN** polished nickel  
**1402-BN** brushed nickel  
**1402-OB** oil rubbed bronze  
 Frame: 2 3/8" X 1 1/4"  
 Card size: 2" X 1"  
 Stamped brass  
*Label holder pull*



**1403-PB** polished brass  
**1403-PN** polished nickel  
**1403-BN** brushed nickel  
**1403-OB** oil rubbed bronze  
 Frame: 3 1/8" X 1 1/2"  
 Card size: 2 7/8" X 1 1/4"  
 Stamped brass  
*Label holder pull*



**1405-PB** polished brass  
**1405-AB** antique brass  
**1405-BN** brushed nickel  
**1405-PN** polished nickel  
**1405-OB** oil rubbed bronze  
 Frame: 2 1/4" X 1"  
 Card size: 1 3/4" X 5/8"  
 Pull projects 11/16"  
 Cast brass  
*Label holder pull*

Label holders with pulls



**1400-PB** polished brass  
**1400-AB** antique brass  
**1400-BN** brushed nickel  
**1400-PN** polished nickel  
**1400-OB** oil rubbed bronze  
 Frame: 3" X 2"  
 Card size: 2 1/4" X 1 1/2"  
 Cast brass  
*Label holder*



**1406-PB** polished brass  
**1406-BN** brushed nickel  
**1406-PN** polished nickel  
**1406-OB** oil rubbed bronze  
 Frame: 2 3/8" X 1 1/4"  
 Card size: 2" X 1"  
 Stamped brass  
*Label holder*

Label holders

*Small*



**1346-PB** polished brass  
**1346-PN** polished nickel  
**1346-OB** oil rubbed bronze  
 3" center to center  
 Solid brass

*Large*



**1149-PB** polished brass  
**1149-PN** polished nickel  
**1149-OB** oil rubbed bronze  
**1149-BN** brushed nickel  
 3 1/2" center to center  
 Solid brass

Early 20th century solid brass handles in two sizes  
 For drawers, file cabinets, display cases, etc.  
 Oval horizontal bar set off-center to bases

*Small*

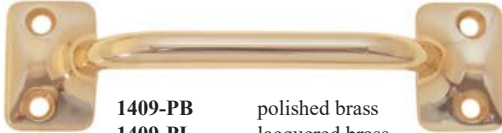

- 1409-PB** polished brass
- 1409-PL** lacquered brass
- 1409-AB** antique brass
- 1409-BN** brushed nickel
- 1409-PN** polished nickel
- 1409-OB** oil rubbed bronze
- 3 1/2" center to center
- 4" overall length
- Solid brass

*Medium*



- 1410-PB** polished brass
- 1410-PL** lacquered brass
- 1410-AB** antique brass
- 1410-BN** brushed nickel
- 1410-PN** polished nickel
- 1410-OB** oil rubbed bronze
- 4" center to center
- 4 3/4" overall length
- 1 3/16" wide
- Solid brass

*Large*



- 1412-PB** polished brass
- 1412-PL** lacquered brass
- 1412-AB** antique brass
- 1412-BN** brushed nickel
- 1412-PN** polished nickel
- 1412-OB** oil rubbed bronze
- 4 3/8" center to center
- 5" overall length
- 1 3/16" wide
- Solid brass

*A larger size than the other two similar handles enabling a better grip*

**Bar handles for file cabinets, drawers, sashes, windows etc.**

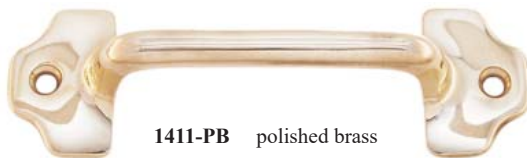

- 1411-PB** polished brass
- 1411-PN** polished nickel
- 3 3/4" center to center
- 4 1/4" overall length
- 1 1/4" wide
- Solid brass

**Metal grommet for desks**



- 6555**
- 2 1/2" inner dia. (hole dia.)
- 3" outer dia. (lid)
- Cable opening: 7/8" wide
- Brass plated Zinc alloy

*Premium quality plate made of thick brass sheet*



- 6547-PB**
- 3 3/4" long
- 1 3/8" high
- Heavy stamped brass

**Keyhole plates for desks**

*Large keyhole plate for desks*



- 1205-PB**
- 5 1/2" long, 1 1/2" high
- Cast brass



**6534**  
 1" wide, 1 1/2" tall,  
 5/16" thick  
 Selvedge to key pin: 3/4"  
 Polished steel  
 With key

*Mortise locks for drawers can also serve in right-hand cabinet doors*

*With extended selvedge and strike plate*



**6535**  
 1" wide , 1 1/2" tall , 5/16" thick  
 Selvedge: 2 1/8" X 3/8"  
 Strike plate: 2 1/8" X 3/8"  
 Selvedge to key pin: 3/4"  
 Steel lock with brass strike plate  
 With key

*Mortise locks for drawers can also serve in right-hand cabinet doors*

*Small*



**6536-PB** polished brass  
**6536-AB** antique brass  
 Plate: 1" X 1 3/4"  
 Brass plated steel  
 With key and keyhole plate

*Left hand*



**6532-LH**  
 1 3/4" wide , 1 5/8" high  
 Selvedge to key pin: 5/8"  
 Polished steel  
 With key  
 Half-mortise lock for drawers  
 and left-hand cabinet doors

*Smaller*

*Right hand*



**6533-RH**  
 1 3/4" wide , 1 5/8" high  
 Selvedge to key pin: 5/8"  
 Polished steel  
 With key  
 Half-mortise lock for drawers  
 and right-hand cabinet doors

*Medium*



**6537**  
 Plate: 1 1/4" X 2 1/2"  
 Brass plated steel  
 With key

**Half-mortise drawer or cabinet door locks in 2 sizes**  
 LH or RH denotes orientation when used on cabinet doors

*Large*



**6538**  
 Plate: 1 3/4" X 3"  
 Polished steel  
 With key

*Left hand*



**6540-LH**  
 1 3/4" wide , 1 7/8" high  
 Selvedge to key pin: 7/8"  
 Polished steel  
 With key  
 Half-mortise lock for drawers  
 and left-hand cabinet doors

*Larger*

*Right hand*



**6540-RH**  
 1 3/4" wide , 1 7/8" high  
 Selvedge to key pin: 7/8"  
 Polished steel  
 With key  
 Half-mortise lock for drawers  
 and right-hand cabinet doors

**Non-mortise locks for cabinets and wardrobes**  
 In 3 sizes  
 Bolts shoot right and left



- 6550-PL** polished brass with lacquer
- 6550-AB** antique brass
- 6550-BK** flat black

Lock case: 1 3/4" wide, 1 3/8" high, 5/16" thick  
 Selvedge: 3 3/8" X 5/8", strike plate: 2 3/4" X 1"  
 Solid brass selvedge, strike plate, and 2 keys  
 Polished steel housing and mechanism  
*Desk lock with rounded corners*  
*Brass plates available in 3 finishes*



**Roll top desk locks with self closing strikes**

Use square-cornered lock to restore antique desks  
 Use round-cornered lock for newly made desks

*Advanced mechanism allows removal of key in the unlocked position*



*Includes keyhole plate*

**6551-PB**

Case: 1 3/4" wide, 1 3/8" high, 5/16" thick  
 Selvedge: 3 1/4" X 5/8", strike plate: 2 3/8" X 1 3/16"  
 Solid brass selvedge, strike plate, keyhole plate, and 2 keys  
 Brass parts are not lacquered  
 Polished steel housing and mechanism  
*Desk lock with square corners*

*A narrow lock for clock cases, cabinets, wardrobes etc.*



**6539**

Case: 1 3/16" W X 2" H X 5/16" D  
 2 7/8" overall height  
 Steel  
 Dark antique copper finish  
*With one key*  
*Bolt shoots left and right*

*Half-mortise lock for chests, boxes, desks, lids, etc.*

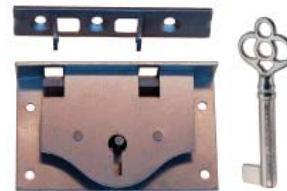

**6546**

2 5/8" W X 1 9/16" H  
 Strike plate: 2 5/8" X 1/2"  
 Selvedge to key pin: 1"  
 Polished steel  
*with one key*

*Skeleton key for house door locks*



- 8730-PB** polished brass
- 8730-PN** polished nickel

Overall length: 3 1/8"  
 Bit is 3/8" X 3/8"  
 High tensile forged brass  
*Well-made key will operate most bit-key locks on the market*

Zinc alloy



**6526-PB** brass plated  
**6526-PN** nickel plated  
 Overall length: 2 7/8" long  
 Bow: 1 1/8" wide  
 Zinc alloy



**6527-PB** brass plated  
 Overall length: 2 1/2" long  
 Bow: 3/4" wide  
 Zinc alloy  
*Fancy bow, larger bit*



**6531-AB** antique brass  
**6531-AC** antique copper  
 Overall length: 2 3/8" long  
 Bow: 3/4" wide  
 Zinc alloy  
*Fancy bow, smaller bit*



**6521-PB** brass plated  
**6521-PN** nickel plated  
 Overall length: 2 1/4"  
 Bow: 3/4" wide  
 Zinc alloy



**6528-PB** polished brass  
**6529-AB** antique brass  
 Overall length: 2 1/2"  
 Bow: 1" wide  
 Zinc alloy  
*Plain bow*



**6552-PB** brass plated  
 Overall length: 2 1/2"  
 Bow: 1 1/8" long  
 Zinc alloy  
*Two-bitted keys for desk locks  
 Sold in pairs*

Solid brass



**6523-PB**  
 Overall length: 3 1/4"  
 Bow: 1 3/8" wide  
 Solid brass  
*Beautifully detailed key  
 For clock cases, cabinets  
 and drawer locks*



**6524-PB**  
 Overall length: 3" long  
 Bow: 1 1/2" wide  
 Solid brass



**6520-PB**  
 Overall length: 2 1/4"  
 Bow: 1" long  
 Solid brass  
*Blank key*



**6525-PB**  
 Overall length: 2 1/4"  
 Bow: 1" long  
 Solid brass  
*Skeleton key*



**6519-PB**  
 Overall length: 2 3/4"  
 Bow: 1 1/8" long  
 Solid brass  
*Skeleton key*



Steel key

**6530-PB** brass plated  
**6530-PN** nickel plated  
 Overall length: 2 3/8" long  
 Bow: 3/4" wide  
 Steel  
*Flat bow*

Keys to fit most drawer / cabinet door locks on the market





**1576-PB** polished brass  
**1576-PN** polished nickel  
**1576-OB** oil rubbed bronze  
 13/16" wide, 1 3/4" high  
 1/2" top diameter  
 Stamped brass  
*Picture molding hook with pressed pattern*



**1577-PB** polished brass  
**1577-PN** polished nickel  
**1577-OB** oil rubbed bronze  
 1 3/4" high  
 3/4" top diameter  
 Half round brass rod  
*For larger molding*

Picture molding hooks



**1578-PB** polished brass  
**1578-PN** polished nickel  
**1578-OB** oil rubbed bronze  
 2" high  
 3/4" top diameter  
 Cast brass  
*Heavy duty picture molding hook*

1 pt.



**6695-ZP**  
 5/8" wide, 3/4" high  
 Steel  
*1-point drawer stops  
 Sold in bags of 50 pcs*

Drawer stops

2 pt.



**6696-ZP**  
 3/4" wide, 3/4" high  
 Steel  
*2-point drawer stops  
 Sold in bags of 50 pcs*



Good Hardware  
 at Good Prices



**1141-PB** polished brass  
**1141-PL** lacquered polished brass  
**1141-PN** polished nickel  
**1141-BN** brushed nickel  
**1141-OB** oil rubbed bronze  
 1 7/16" X 1 3/4"  
 Solid brass  
*Flush (recessed) ring pull*



**4217-C**  
 1 3/16" dia.  
 1 1/4" projection  
 Cherry



**4217-M**  
 1 3/16" dia.  
 1 1/4" projection  
 Maple



**4217-O**  
 1 3/16" dia.  
 1 1/4" projection  
 Oak



**4217-W**  
 1 3/16" dia.  
 1 1/4" projection  
 Walnut

With threaded insert at base to take  
 8-32 machine screw (not supplied)

Shaker knobs

*Sm.*



**4210**  
 1 1/16" dia.  
 3/4" projection  
 3/8" tenon dia.  
 Beech

*Med.*



**4212**  
 1 3/8" dia.  
 1 1/8" projection  
 1/2" tenon dia.  
 Beech

*Lg.*



**4213**  
 1 7/8" dia.  
 1 5/8" projection  
 5/8" tenon dia.  
 Beech



*Large*

Walnut "fruit" pull

**4341**  
 9" wide  
 3" high  
 Walnut

For Victorian and Eastlake  
 walnut and oak furniture

*Smaller*



**4347** walnut  
**4367** oak  
 1 1/16" dia.  
*Round*

*Larger*



**4348** walnut  
**4368** oak  
 1 1/4" dia.  
*Round*



**4349** walnut  
**4369** oak  
 1 1/4" side  
*Diamond shaped*

Wooden keyhole plates



**4265** oak  
**4365** walnut  
 2 1/4" X 1 1/2"  
 7/8" projection  
 Diamond shaped knob  
 with 8-32 threaded insert  
 and screws



Small



Medium

**4200**  
 3/4" square  
 13/16" project.  
 Oak

*Pyramid  
 oak knobs  
 With 8-32 threaded  
 inserts and screws*

**4201** oak  
**4201-BK** black  
**4201-C** cherry  
**4201-WI** walnut  
 1 1/4" square  
 7/8" projection  
 Oak and other woods

Large



**4203**  
 1 3/4" square  
 1 1/8" projection  
 Oak



*With 8-32 threaded  
 inserts and screws*

**4205** pyramid handle  
 3" center to center  
 4 1/2" X 1 3/8" overall size  
 1 1/8" projection  
 Oak

**Solid oak Arts & Crafts / Mission knobs and handle**



*With 8-32 threaded  
 inserts and screws*

**4426** desk/drawer handle  
 7 1/4" wide , 1 5/8" high  
 5" center to center  
 Oak



*Carved oak pull with 8-32  
 threaded inserts and screws*

**4425** drawer pull  
 6" wide , 2" tall  
 3" center to center  
 Oak



**4411** desk handle  
 5" wide, 1 1/4" high  
 1" projection  
 Oak  
 Plain

*Smaller handles with threaded inserts at 3 3/4" center to center and screws*



**4421** desk handle  
 5" wide, 1 1/4" high  
 1" projection  
 Oak  
 Carved

**4412** desk handle  
 7" wide, 1 1/4" high  
 1" projection  
 Oak  
 Plain



*Larger handles with threaded inserts at 5 1/2" center to center and screws*

**4422** desk handle  
 7" wide, 1 1/2" high  
 1 1/8" projection  
 Oak  
 Carved





*Small*



**4286** oak  
**4386** walnut  
1 1/2" dia.  
7/8" projection

*Medium*



**4288** oak  
**4388** walnut  
2" dia.  
1" projection

*Smallest*



**4250**  
3/4" dia.  
3/4" projection  
Oak

*Small*



**4251**  
1" dia.  
15/16" projection  
Oak

*Medium*



**4252**  
1 1/4" dia.  
1" projection  
Oak

**Oak knobs in 5 sizes**

*Large*



**4253**  
1 1/2" dia.  
1" projection  
Oak

*Largest*



**4254**  
1 3/4" dia.  
1" projection  
Oak



**4901**  
Base dia.: 2 1/2"  
Opening dia.: 1 5/8"  
Oak  
*Caster cup*

*Hardwood caster cup to protect the floor  
For casters with a diameter of up to 2"*

**Large wood knobs for old houses  
kitchens and bathrooms  
and traditional furniture**



**4275** oak  
**4375** walnut  
1 3/8" dia.  
1 1/4" projection



**4277** oak  
**4377** walnut  
1 3/4" dia.  
1 5/8" projection



**4278** oak  
**4378** walnut  
2" dia.  
1 3/4" projection



**4280** oak  
**4380** walnut  
2 1/2" dia.  
1 3/4" projection

**All wood products are sanded and unstained  
ready to take a finish**



**5683**  
1" dia.  
15/16" projection  
White porcelain  
*With 1 machine screw*



**5684**  
1 1/4" dia.  
1 1/16" projection  
White porcelain  
*With 1 machine screw*



**5685**  
1 1/2" dia.  
1 1/4" projection  
White porcelain  
*With 1 machine screw*



**5697**  
2" dia.  
1 3/8" projection  
White porcelain  
*With 1 machine screw*

White porcelain knobs for furniture and cabinets  
with embedded 8-32 threaded insert  
Screw is installed from the back



**5671**  
1/2" dia.  
1/2" projection  
White porcelain  
*With 1 machine screw*



**5672**  
3/4" dia.  
5/8" projection  
White porcelain  
*With 1 machine screw*



**5673**  
1" dia.  
7/8" projection  
White porcelain  
*With 1 wood screw  
and 1 machine screw*



**5674**  
1 1/4" dia.  
1" projection  
White porcelain  
*With 1 wood screw  
and 1 machine screw*



**5675**  
1 1/2" dia.  
1" projection  
White porcelain  
*With 1 machine screw*

White porcelain knobs with brass plated screws  
For furniture, shutters, pictures etc.  
Screw goes through the center of the knob

Small



**5305-PB** polished brass base  
**5305-PN** polished nickel base  
 1 3/16" dia. , 1 1/8" projection  
 Shank 1/2" long  
*Clear glass with brass base*

Colonial pattern clear glass knobs  
 In 2 sizes, with 2 base finishes



Large



**5304-PB** polished brass base  
**5304-PN** polished nickel base  
 1 3/4" dia. , 1 3/8" projection  
 Shank 1/2" long  
*Clear glass with brass base*

Small



**5306-PB** polished brass base  
**5306-PN** polished nickel base  
 1" dia.  
 Brass base  
*6-sided glass knob*

Medium



**5307-PB** polished brass base  
**5307-PN** polished nickel base  
 1 1/4" dia.  
 Brass base  
*6-sided glass knob*



Large

**5308-PB** polished brass base  
**5308-PN** polished nickel base  
 1 7/8" dia.  
 Clear glass knob  
 Brass base  
*6-sided knob  
 Extra large size*

6-sided star-shaped clear glass knobs and handle

Brass bases in polished brass or polished nickel  
 1/2" long brass shanks - equipped with 5/8" long screws



**5309-PB** polished brass base  
**5309-PN** polished nickel base  
 2 15/16" center to center  
 Brass bases  
*6-sided posts*

**IMPORTANT  
 INSTALLATION INSTRUCTIONS:**

Glass knobs with brass base - where the screws come from the back and screw into the threaded shank.

Use only hand tools to install glass knobs or pulls on your cabinets. Power tools may cause damage to the thread, the shank or the base.

Hold the knob and turn the screw. Do not turn the knob against the drawer or door wall.

Tighten carefully , but do not overtighten.

Make sure the screw is not too long for the job in order to avoid turning the shank in the base - we include screws that are 5/8" long.



**5590** clear  
**5593** opal  
**5597** amber  
**5598** depres. pink  
**5599** purple  
 1 3/4" dia.  
 1 3/8" projection  
*Colonial glass knob*  
*Very large knob with threaded insert - installed with screw from the back*



**5504** clear  
**5534** opal  
**5544** black  
**5554** Depression green  
**5584** peacock blue  
 1 1/8" dia.  
 1 1/8" projection  
*With a 2 1/2" long N/P bolt*  
*Round "Beehive" glass knob*



**5502** clear  
**5512** cobalt blue  
**5532** opal  
**5572** amber  
 1 1/8" dia.  
 1 1/8" projection  
*Round "Mushroom" glass knob*  
*With a 2-1/2" long N/P bolt*



**5297** clear glass  
 1 1/4" dia.  
 Glass shank 1/2" dia.  
 Includes brass sleeve  
  
*Hex Glass Knob with threaded glass shank can be installed directly unto the wood or with the brass sleeve*



**5297-F** sleeve for Glass Knob  
 5/8" long, 1/2" dia.  
 Stamped brass  
*Used to install glass knob above*  
*Can be ordered by itself*

*Small*



**5206** clear  
**5216** cobalt blue  
**5246** black  
**5256** Depression green  
**5276** amber  
 1" dia.  
*Fluted glass knob*

*Medium*



**5207** clear  
**5217** cobalt blue  
**5247** black  
**5257** Depression green  
**5277** amber  
 1 1/4" dia.  
*Fluted glass knob*

*Large*



**5208** clear  
**5218** cobalt blue  
**5248** black  
**5258** Depression green  
**5278** amber  
 1 1/2" dia.  
*Fluted glass knob*  
*With 3" bolt*

**Fluted glass knobs and a handle in 6 colors**  
 2 1/2" long nickel-plated bolts included



**5209** clear  
**5219** cobalt blue  
**5249** black  
**5259** Depression green  
**5279** amber  
 3" center to center  
*Fluted glass handle*



**5296-PN-1.00** nickel plated  
**5296-PN-1.25** nickel plated  
**5296-PN-1.50** nickel plated  
**5296-PB-1.00** brass plated  
**5296-PB-1.25** brass plated  
**5296-PB-1.50** brass plated  
 Post: 7/32" dia., 7/8" long  
 Screw length: 1.00" or 1.25" or 1.50"  
 Steel posts and screws

*Posts & Screws: an alternative way to install glass knobs and handles. There are 3 lengths of screws corresponding to sizes of knobs. Please specify size when ordering (for handles order 1.25" screws).*



1" dia.

- 5201 clear
- 5211 cobalt blue
- 5221 ruby red
- 5231 white
- 5241 black
- 5251 Depression green
- 5261 forest green
- 5271 amber
- 5281 Depression pink
- 5151 opal
- 5161 milk blue
- 5171 milk green (jade)
- 5191 purple

1" dia.  
Hex Glass Knobs  
With a 2 1/2" long N/P bolt



1 1/4" dia.

- 5202 clear
- 5212 cobalt blue
- 5222 ruby red
- 5232 white
- 5242 black
- 5252 Depression green
- 5262 forest green
- 5272 amber
- 5282 Depression pink
- 5152 opal
- 5172 milk green (jade)
- 5182 peacock blue
- 5192 purple

1 1/4" dia.  
Hex Glass Knobs  
With a 2 1/2" long N/P bolt



3" center to center

Glass "bridge" handle

- 5205 clear
- 5215 cobalt blue
- 5225 ruby red
- 5245 black
- 5255 Depression green
- 5265 forest green
- 5275 amber
- 5285 Depression pink
- 5155 opal
- 5175 milk green (jade)
- 5185 peacock blue
- 5195 purple

3" center to center  
1 1/4" hexagonal posts  
With two 2 1/2" long nickel-plated bolts

Hexagonal glass knobs and handles in 14 colors



1 1/2" dia.

- 5203 clear
- 5213 cobalt blue
- 5223 ruby red
- 5233 white
- 5243 black
- 5253 Depression green
- 5263 forest green
- 5273 amber
- 5283 Depression pink
- 5153 opal
- 5163 milk blue
- 5173 milk green (jade)
- 5183 peacock blue
- 5193 purple

1 1/2" dia.  
Hex Glass Knobs  
With a 3" long N/P bolt



1 7/8" dia.

5204 clear  
1 7/8" diameter  
Hex Glass Knobs  
With a 3" long N/P bolt

**IMPORTANT INSTALLATION INSTRUCTIONS**

Glass knobs with bolt inserted from front through head of knob:

Use only hand tools to install glass knobs or pulls on your cabinets. Power tools may cause damage to the thread or to the knobs. To tighten, turn only the nut on the back of the screw (this is one reason that the heads of the screws are smooth on top and do not have a slot). Do not turn the knob itself as it may cause breakage. Tighten the nuts carefully but do not over-tighten - remember they are made of glass so are fragile.



**Bolts for Glass Knobs & Handles**

- 5291-PN nickel plated 2 1/2" long
- 5292-PB brass plated 2 1/2" long
- 5293-PN nickel plated 3" long
- 5294-PB brass plated 3" long

*Authentic pan-head screws come with square nuts. The heads of the screws are smooth. The upper part of the stem is threadless for better appearance.*





5205  
Clear



5275  
Amber



5155  
Opal



5195  
Purple



5185  
Peacock  
blue



5175  
Jade green



5215  
Cobalt blue



5255  
Depression green



5225  
Ruby red



5245  
Black



5265  
Forest green



Octagonal glass knobs and handles with brass bases



Amber

Available with 4 choices for the finish of the base:  
Polished Brass, Polished Nickel, Brushed Nickel, and Oil rubbed Bronze  
Please specify base finish when ordering



Depression Green



Amber



Black



Black

Depression Green



Amethyst



Opal

The posts of the handle are the same size as the medium size knobs on the right hand side of this page

Opal



Bridge handle 3" CC



Clear glass

Clear glass



Medium size knob

- 5752-PB clear
- 5752-PN clear
- 5752-BN clear
- 5752-OB clear
- 5754-PB opal
- 5754-PN opal
- 5754-BN opal
- 5754-OB opal
- 5755-PB Depression green
- 5755-PN Depression green
- 5755-BN Depression green
- 5755-OB Depression green
- 5756-PB black
- 5756-PN black
- 5756-BN black
- 5756-OB black
- 5757-PB amber
- 5757-PN amber
- 5757-BN amber
- 5757-OB amber

3" center to center  
1 1/4" post diameter  
1 1/4" projection  
Glass "bridge" handles with octagonal posts  
5 colors with 4 base finishes:  
PB,PN, BN and OB.

- 5722-PB clear
- 5722-PN clear
- 5722-BN clear
- 5722-OB clear
- 5723-BN amethyst
- 5723-OB amethyst
- 5724-PB opal
- 5724-PN opal
- 5724-BN opal
- 5724-OB opal
- 5725-PB Depression green
- 5725-PN Depression green
- 5725-BN Depression green
- 5725-OB Depression green
- 5726-PB black
- 5726-PN black
- 5726-BN black
- 5726-OB black
- 5727-PB amber
- 5727-PN amber
- 5727-BN amber
- 5727-OB amber

1 1/4" dia.  
1 3/16" projection  
Octagonal glass knob  
Brass base  
6 colors with 4 base finishes:  
PB,PN, BN and OB.



Octagonal glass knobs with brass bases

Available with 4 choices for the finish of the base:  
 Polished Brass, Polished Nickel, Brushed Nickel, and Oil rubbed Bronze  
 Please specify base finish when ordering



Black



Amber



Depression Green



Amethyst



Opal



Clear glass

Small knob

- 5712-PB clear
- 5712-PN clear
- 5712-BN clear
- 5712-OB clear
- 5713-BN amethyst
- 5713-OB amethyst
- 5714-PB opal
- 5714-PN opal
- 5714-BN opal
- 5714-OB opal
- 5715-PB Depression green
- 5715-PN Depression green
- 5715-BN Depression green
- 5715-OB Depression green
- 5716-PB black
- 5716-PN black
- 5716-BN black
- 5716-OB black
- 5717-PB amber
- 5717-PN amber
- 5717-BN amber
- 5717-OB amber

1" dia.  
 15/16" projection  
 Octagonal glass knob  
 Brass base  
 6 colors with 4 base finishes:  
 PB, PN, BN and OB



Depression Green



Black



Opal



Clear glass

Large knob

- 5732-PB clear
- 5732-PN clear
- 5732-BN clear
- 5732-OB clear
- 5734-PB opal
- 5734-PN opal
- 5734-BN opal
- 5734-OB opal
- 5735-PB Dep. green
- 5735-PN Dep. green
- 5735-BN Dep. green
- 5735-OB Dep. green
- 5736-PB black
- 5736-PN black
- 5736-BN black
- 5736-OB black

1 1/2" dia.  
 1 1/4" projection  
 Octagonal glass knob  
 Brass base  
 4 colors with 4 base finishes :  
 PB, PN, BN and OB



**Wall display program**  
Call for more information

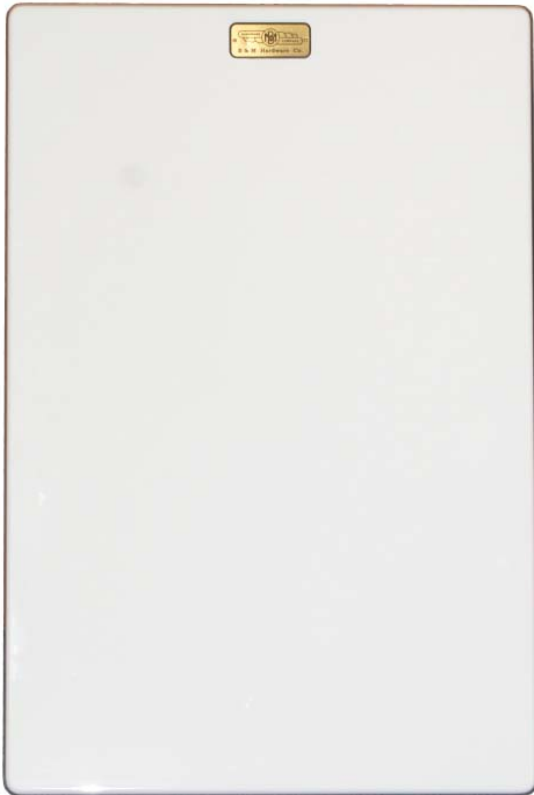

**DB-05** Blank Display  
16" X 24"  
3/4" thickness  
White laminated

*B&M Hardware Co. wall display board. We sell blank (unmounted) boards because we have so many products and different customers need different samples. Display board samples are offered at 50% off base prices.*

**Table / shelf displays**  
for door hardware  
Call for more information



**DS-05/06/07/08/09**  
Base: 8 1/4" X 5 1/2"  
Height: 13"

*B&M Hardware Co. display stands for doorknobs, roses and escutcheon plates feature various groupings of our doorknobs and trim. We can make them with any combination of trim and knobs that you prefer.*